

Manuscript version: Author's Accepted Manuscript

The version presented in WRAP is the author's accepted manuscript and may differ from the published version or Version of Record.

Persistent WRAP URL:

<http://wrap.warwick.ac.uk/176917>

How to cite:

Please refer to published version for the most recent bibliographic citation information. If a published version is known of, the repository item page linked to above, will contain details on accessing it.

Copyright and reuse:

The Warwick Research Archive Portal (WRAP) makes this work by researchers of the University of Warwick available open access under the following conditions.

© 2023 Elsevier. Licensed under the Creative Commons Attribution-NonCommercial-NoDerivatives 4.0 International <http://creativecommons.org/licenses/by-nc-nd/4.0/>.



Publisher's statement:

Please refer to the repository item page, publisher's statement section, for further information.

For more information, please contact the WRAP Team at: wrap@warwick.ac.uk.

*******This is the final draft of the paper submitted to the journal Resources, Conservation and Recycling. For the official version please refer to DOI: 10.1016/j.resconrec.2014.12.004*******

Title: Extending the Theory of Planned Behavior in the context of recycling: the role of moral norms and of demographic predictors

Authors: Iosif Botetzagias^{1,2}, Andora-Fani Dima², Chrisovaladis Malesios³

¹: Department of Environment, University of the Aegean, University Hill, Mytilene 81100, Greece, email: iosif@aegean.gr

²: School of Economics, Business Administration & Legal Studies, International Hellenic University, Thessaloniki-Thermi 57001, Greece

³: Department of Agricultural Development, Democritus University of Thrace, 193 Pantazidou Street, Orestiada 68200, Greece

ABSTRACT

This paper examines how an individual's moral norms and demographic characteristics interact with the standard 'Theory of Planned Behavior' predictors (Attitude; Subjective Norms; and, Perceived Behavioral Control (PBC)) in explaining the intention to recycle (RI). Our data originates from an empirical research of Greek citizens conducted in Autumn 2013 (N =293). Through structural equation modeling, we find that PBC is consistently the most important predictor of RI. Moral Norms have a larger effect on RI than Attitude while their influence is primarily direct. On the contrary, demographic characteristics were found to be statistically non significant predictors of RI, similarly to Subjective Norms.

Keywords: Theory of planned behavior, recycling, moral norms; demographic characteristics

Highlights

- We expand the Theory of Planned Behavior (TPB) with moral norms and demographics in the context of recycling.
- Moral Norms are an important and largely independent predictor of recycling
- Demographics have statistically non significant influence
- Of the TPB predictors, Subjective Norms' influence was consistently found to be non significant

1. Introduction

Recycling benefits the environment in two ways, by minimizing waste and by conserving natural resources, thus it is one of those pro-environmental behaviors which 'consciously seeks to minimize the negative impact of one's actions on the natural and built world' (Kollmuss and Agyeman, 2002:240). The 'waste problem' demands a solution on a local, national and international level. Technological advances are one part of the equation. The other part is human behavior and decision-making related to recycling. The decision to recycle is a complex one since many factors have to be taken into account. Available research has identified the convenience of the available recycling infrastructure, related recycling programs, awareness of the consequences of recycling, environmental knowledge and concern, type and area of residence, perceived social pressure, legislation, attitudes towards recycling, promotional campaigns amongst the many factors which may influence recycling decisions (e.g. Davies *et al.*, 2002; Barr *et al.*, 2003; Tonglet *et al.*, 2004).

In this paper we are interested in examining recycling intention in the light of one of the most influential psychological theories, the Theory of Planned Behavior (TPB) (Ajzen, 1991). While a number of studies have explored recycling through the TPB framework (Boldero, 1995; Chan, 1998; Cheung *et al.*, 1999; Davies *et al.*, 2002; Tonglet *et al.*, 2004; Knussen *et al.*, 2004; Manetti *et al.*, 2004; Davis *et al.*, 2006; Knussen and Yule, 2008; Chen and Tung, 2010; Nigbur *et al.*, 2010; Bezzina and Dimech, 2011; Ramayah *et al.*, 2012; Chan and Bishop, 2013), we expand the interpretative schema by introducing two additional clusters of predictors, moral concerns and demographic variables: while the former has been being increasingly

used in tandem with the standard TPB predictors (e.g. Tonglet *et al.*, 2004; Klockner, 2013; Chen and Tung, 2010; Chan and Bishop, 2013) the latter, to the best of our knowledge, has never been in conjunction with TPB-moral concerns for explaining recycling behavior. Thus, this paper aims to address two questions. First, and similar to Chan and Bishop (2013), how do moral considerations operate within the established framework of Theory of Planned Behavior for recycling? Second, how do demographic variables influence the various psychological/moral constructs and do they have a distinct impact on recycling behavior?

2. Literature Review

2.1 The role of moral norms

The Theory of Planned Behavior (TPB) is one of the most influential and commonly used psychological theories for explaining pro-environmental behaviors. For TPB, most human behaviors are goal-directed behaviors (Ajzen, 1985:11) thus a person would behave pro-environmentally because s/he has the “Intention” to do so. This “Intention” is influenced by the person’s “Attitude”, “Subjective Norms” and “Perceived Behavioral Control, PBC” (see Figure 1 for a graphical depiction of the theory using ‘recycling’ as the performed behavior). The “Attitude” toward the behavior refers to the evaluation of the particular behavior's likely outcomes; the “Subjective Norms” relates to whether the social milieu approves or not the particular behavior as well as to which extent the individual is influenced by his/hers societal surroundings; and, finally, the “PBC” taps on the individual’s perceived ability to perform the behavior.

While discussing the ‘sufficiency’ of the TPB, Ajzen (1991:199) noted that the theory is in principle open to the inclusion of additional explanatory variables, as long as they can be shown to have a significant and distinct contribution. Thus, the majority of the studies employing TPB in the context of recycling behavior have tried to incorporate additional predictors. Moral norms, situational factors and past behavior are the ones most commonly used and generally perceived as enhancing the predictive ability of the standard TPB constructs (e.g. Boldero, 1995; Tonglet *et al.*, 2004; Davis *et al.*, 2006; Chan and Bishop, 2013). Self-identity (Manetti *et al.*, 2004; Nigbur *et al.*, 2010), perception of mass media (Chan, 1998), environmental

knowledge (Cheung *et al.*, 1999; Ramayah *et al.*, 2012), and perceived habit (or lack of it) of recycling (Knussen *et al.*, 2004; Knussen and Yule, 2008) have also been used with mixed results.

Amongst the various possible additional predictors, moral norms hold a special place, not least because Ajzen (1991) himself argued that ‘personal or moral norms’, that is the ‘*personal* feelings of moral obligation or responsibility to perform [...] a certain behavior’ (ibid.) may have a significant contribution to the explained variance of behavior. Actually, in the early formulation of TPB (Fishbein, 1967), personal norm along with social norm constituted the normative component of the theory. Yet, the personal element was later removed from the model because it was perceived as an alternative measure for behavioral intention due to those two variables’ high correlation (Harland *et al.*, 1999). Nevertheless, the relevance and role of ‘personal’ or ‘moral’ norms has been a recurring point of debate in the TPB literature. While the two terms have been used interchangeably in the literature (e.g. compare Bamberg and Moser (2007:15) with Biel and Thøgersen (2007:102)), the more appropriate term is ‘personal moral norms’. Following Schwartz (1977), we consider personal norms to be internalized norms, ‘the reflection of a personal value system in a given situation’ (Klockner, 2013:1030). Spurred by situational cues, a person’s value system may ‘generate feelings of moral obligation to perform or refrain from specific actions’ (Biel and Thøgersen, 2007:102). In effect, then, most of the critique on the traditional TPB framework rests on the idea that performing some behaviors would not depend merely on the rational, cost-benefit calculations inherent in TPB but also on motives of a selfless, altruistic or pro-social nature, on the presence/activation of a ‘personal moral norm’. Thus, and concerning recycling in particular, a number of studies have incorporated moral concerns to the TPB framework, with varied results (e.g. Tonglet *et al.*, 2004; Davis *et al.*, 2006; Chen and Tung, 2010; Chan and Bishop, 2013).

Despite the growing support in favor of including “moral norms”¹ (MN) as an additional predictor, as well as the accumulating evidence that MN explains a significant portion of the variance in pro-environmental behaviors (cf. Bamberg and Moser, 2007), there is some debate as to how moral norms should be fitted in TPB framework. In effect, there are two possibilities (cf. Turaga *et al.*, 2010:217): either

¹ Henceforth, when referring to ‘moral norms’ we will mean the already described ‘personal moral norm’ concept, unless otherwise clearly stated.

moral norms have a predominantly direct effect on behavior, which implies that they are largely unrelated to the TPB constructs (e.g. Harland *et al.*, 1999); or, that their effect is mainly indirect and mediated through the various TPB constructs (e.g. Ajzen, 1991), which implies that moral norms are highly correlated with some TPB concepts. Latest reviews of available research point towards the second explanation: thus, as (Klockner, 2013:1035) concludes, based on his meta-analysis of available research, “Part of the impact of personal [moral] norms on intentions is mediated by attitudes, meaning that what people consider favourable also takes into account if the respective behaviour is in line with personal values”.

As far as recycling is concerned, the mediated impact of moral norms on behavior has not been empirically test. Available studies examined only direct effects and focused on the existence or not of discriminant validity between ‘moral norms’ and ‘attitude’, with divergent results (Chen and Tung 2010; Chan and Bishop 2013). Accordingly, the first objective of this paper is to empirically test (a) whether the inclusion of a ‘moral norms’ predictor increases the explained variance of recycling intention compared to the standard TPB predictors, and (b) whether the effect of ‘moral norms’ on intention is largely indirect and mediated through the ‘attitude’ construct of the TPB. This will be done by comparing three structural equation models: Model A (the standard TPB model, see Figure 1); Model B (where the Attitudes predictor is replaced with Moral Norms, see Figure 2) and Model C (where Moral Norms are supposed to influence Recycling Intention both directly and indirectly –through the Attitude predictor-, see Figure 3).

Figure 1: Model A (standard TPB predictors)

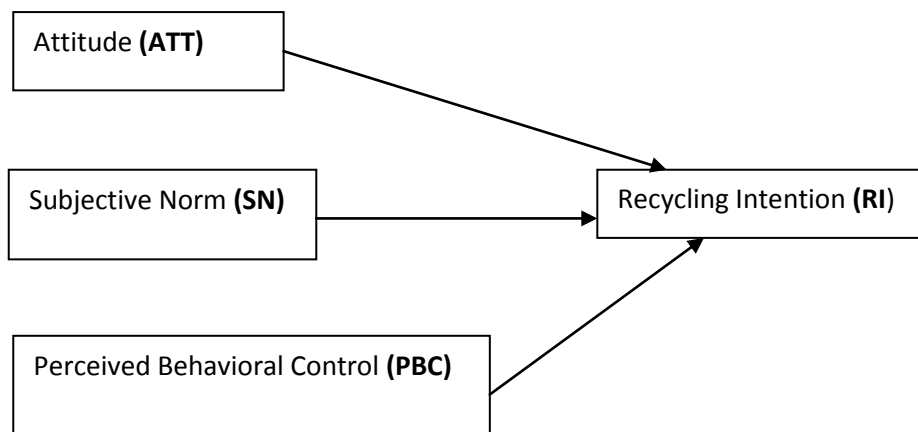

Figure 2: Model B (Attitude predictor replaced by Moral Norms)

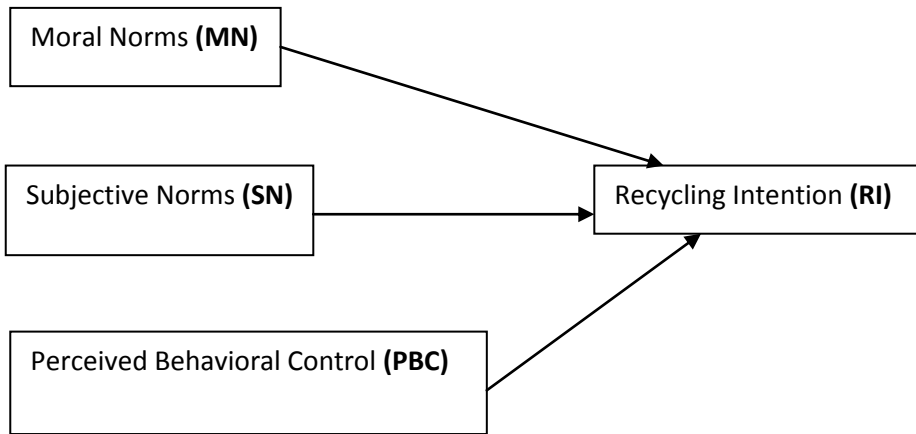
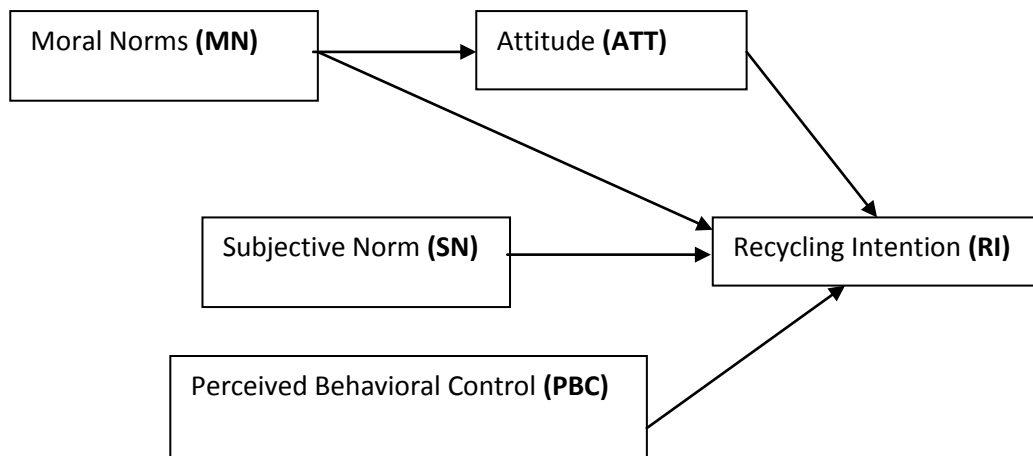

Figure 3: Model C (Moral Norms included as an additional predictor to standard TPB)



2.2 The role of socio-demographics

The interaction between socio-demographic variables (such as age, gender, educational and social background) and the TPB constructs has rarely received attention in the literature, both in general (e.g. Christian *et al.*, 2007) and for pro-environmental behaviors in particular, such as recycling. One reason for this may be that while numerous studies have used socio-demographic indicators in an attempt to establish the recycler's profile, they haven't reached a consensus (e.g. Davies *et al.*, 2002) while there exists no strong evidence that socio-demographics directly predict recycling behavior (Boldero, 1995; Chan, 1998; Knussen, Yule, MacKenzie, and Wells, 2004). Thus, in terms of profiling and segmentation, the use of socio-demographics seems to have hit a dead end. Furthermore, and perhaps more importantly, this limited attention may also be attributed to the fact that the Theory of Planned Behavior has assumed that structural variables, such as socio-demographics, influence intentions and behavior indirectly, through the TPB main constructs (Ajzen and Fishbein, 1980). In other words, psychological variables are assumed to mediate the effect that socio-demographic variables (e.g. age) have on intentions and behavior.

Nevertheless, to the authors' best knowledge, no prior studies have investigated the *relations* between socio-demographic variables, the classic TPB predictors and the intention to perform a pro-environmental behavior, recycling included. We consider this an important lacuna in our knowledge since socio-

demographic variables pose or influence *real* possibilities and/or constraints that individuals face, in contrast with the *perceived* nature of the psychological variables, as Abrahamse and Steg (2011:31) have pointed out. As a matter of fact, the handful of studies which tested socio-demographic in tandem to psychological predictors found that the former have an additional/distinct effect on pro-environmental behaviors (e.g. Chowdhury and Ceder (2013) for transportation choices; Abrahamse and Steg (2011), Botetzagias *et al.* (2014) and Eluwa and Siong (2013) for energy conservation). Of these studies, Abrahamse and Steg (2011) and Botetzagias *et al.* (2014) employed regression models, which do not allow for discerning the possible interactions between the predictor variables, while Eluwa and Siong (2013) and Chowdhury and Ceder (2013), despite using Structural Equation Modeling (SEM), did not allow/check for any interactions between the predictors. In this paper we also use a SEM approach since we are interested in establishing whether the demographic variables influence the intention to recycle only indirectly, through the TPB predictors -as it is widely assumed-, or whether they also have a direct effect.

Accordingly, we will test two more SEM models. Model A1 (Figure 4) is an extended version of Model A, in which we test for the direct and indirect (through the standard TPB predictors) effects of the demographic variables on Recycling Intention (RI).

Figure 4: Model A1 (standard TPB predictors plus demographic variables)

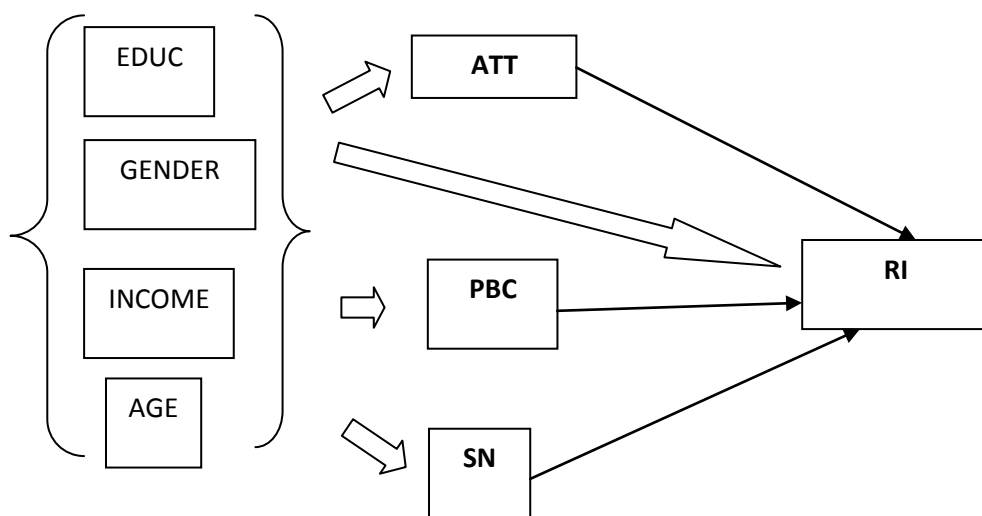

Next, we will check how the demographic predictors perform in the context of the Moral Norms' predictors. Thus, depending on which of the two Models B and C presented in the previous sub-section will be found to better fit the data, we will proceed with testing an extended version of that model in which the demographic variables will be included as further predictors of RI.

3. Data & Methods

3.1 Context and Sample

The existing recycling framework in Greece is known as the “Blue Bin” system. It is a co-managed scheme run jointly by the Central Union of Greek Municipalities (CUGM) and the Hellenic Recovery Recycling Corporation (HERRCO), a corporation founded in 2001 by companies which produce packaging materials or trade packaged goods. Through this scheme, individuals may drop their recyclable waste of glass, paper, plastic, aluminium and tinplate into the bin, without the need to separate them and without being offered any explicit and immediate reward. At the time of research, the scheme covered around 90% of the Greek population (HERRCO, 2014).

In Autumn 2013 we uploaded online a questionnaire asking participants to express, under conditions of anonymity, their views about recycling. On the first page of the questionnaire a brief definition of recycling was offered, followed by a number of questions about the respondent's views concerning recycling through the “Blue Bin” system. The questionnaire was communicated electronically through the academic email databases of three Greek Universities (International Hellenic University, University of the Aegean and University of Macedonia) as well as through these Universities' social media (Facebook) pages, requesting recipients/readers not only to participate in the research but also to inform their personal and social networks of this research and to invite them to participate as well. The online questionnaire remained available between October 26 and November 20, 2013 and a total of 293 individual responses were collected.

The sample used poses certain limitations to the present study. The fact that this sample was self-selected may have introduced a bias, with those more environmentally concerned/active being more likely to take the time to fill in the questionnaire and thus being over-represented in our sample (cf. Hage *et al.* 2009).

Furthermore, our sample is certainly not representative of the Greek population, with females, younger and highly educated individuals constituting the bulk of respondents (see Table X1 in the Appendix). All these characteristics are expected to restrict the variability and to result in weakened correlations. We will return to these points in the concluding section of the paper.

3.2 Variables used

The construction of the questionnaire followed the instructions by Ajzen (2002:1991) and used established measurement scales and indicators adopted in previous studies by Tonglet *et al.* (2004), Kaiser (2006), Chen and Tung (2010) and Chan and Bishop (2013) who employed TPB in order to investigate recycling intention. Items were adapted to the requirements of this research but the general style of these studies was followed and all measures conform to common assessment practices in this field. All variables were measured on a 7-point Likert scale ranging from '1' (disagreement/negative stance) to '7' (agreement/positive stance) with '4' serving as a neutral stance.

Dependent (manifest) variable: The dependent variable in our analysis is the respondent's intention to recycle (RI). In particular, the respondent was asked to denote '*How likely is it that you will recycle your recyclable waste through the Blue Bin system over the next month?*' ranging from 'Not at all likely' (1) to 'Very much likely' (7). Following Ajzen (2002) and Harland *et al.* (1999) we explicitly set a time frame ('over the next month') in order to make sure that all respondents focused and considered the same time period while answering the questionnaire.

Predictor latent variables

"Attitude" (ATT): A 6 items' scale (Cronbach's $\alpha= 0.756$), (*Recycling through the Blue Bin system over the next month is: bad/good; a waste of time/useful; not rewarding/rewarding; not responsible/responsible; not hygienic/hygienic*)

"Subjective Norms" (SN): A 3-items' scale (Cronbach's $\alpha= 0.767$), (*most people who are important to me think that I should recycle my household waste through the Blue Bins; most people who are important to me would approve of me recycling my*

household waste through the Blue Bins; most people who are important to me recycle their household waste in the Blue Bins)

“Perceived Behavioral Control” (PBC): A 7-items’ scale (Cronbach’s $\alpha = 0.802$), (*I have plenty of opportunities to recycle my household waste in the Blue Bins; Recycling my household waste through the Blue Bins is inconvenient (reversed); Recycling through the Blue Bins is easy; The local council provides satisfactory opportunities for recycling; I know what items of household waste can be recycled through the Blue Bins; I know where to find a Blue Bin to take my household waste for recycling; I know how to recycle my household waste through the Blue Bins*).

“Moral Norms” (MN): A 2-items’ scale (Cronbach’s $\alpha = 0.848$), (*It is morally responsible...; it is my moral obligation... to other people and/or the environment that I recycle my waste in the Blue Bins*)

Predictor manifest variables

Finally the questionnaire included questions on the respondent’s Gender, Age group, Income level and Educational attainment (see Table X1 in the Appendix for the sample’s demographic characteristics).

4. Results

4.1 The role of the moral norms

The correlations between the various predictors are reported in Table 1. In order to test the influence of moral norms on an individual’s recycling intention, we start by fitting three structural equation models, respectively testing the conceptual models presented in Figures 1 to 3. The SEM models were estimated through the AMOS software (Arbuckle, 2006). The path diagrams obtained by the fit of our models are shown in Figures 5 to 6. For clarity reasons, only the latent predictors, and not their respective manifest variables, are shown in these Figures. The single-headed arrows are used to imply the direction of assumed causal influence while the numerical values next to each arrow are the standardised ‘path coefficients’ (i.e.

regression coefficients). Not statistically significant ($p > 0.1$) paths are not depicted in the following Figures. Finally, in Table 2 we report the direct, indirect and total effects of the predictor variables on Recycling Intention as well as the Models' goodness-of-fit indices. Treatment of indirect effects (i.e. calculation of indirect path regression coefficients and the corresponding significances) was performed via AMOS as the products of the corresponding direct paths and implemented into the path analysis model through the user-defined estimand choice.

Table 1: Pearson's correlation coefficients along with their significance for the TPB & Moral predictors and the dependent variable (Recycling Intention)

	ATT	SN	PBC	MN	RI
Attitude (ATT)	-				
Subjective Norms (SN)	0.168***	-			
Perceived Behavioral Control (PBC)	0.231***	0.412***	-		
Moral Norms (MN)	0.583***	0.265***	0.298***	-	
Recycling Intention (RI)	0.323***	0.352***	0.606***	0.380***	-

***: Correlations are significant at a 1% level of significance

Model A in Figure 5 depicts the standard TPB model and explains 43.9% of the recycling intention's variance (R^2 , squared multiple correlation). While the goodness-of-fit indices are within the accepted boundaries for close fit (Hu and Bentler, 1999), Subjective Norms were found to be a statistically non significant predictor of Recycling Intention. We will return to this finding in the Discussion section of the paper.

Figure 5: Model A path analysis' results

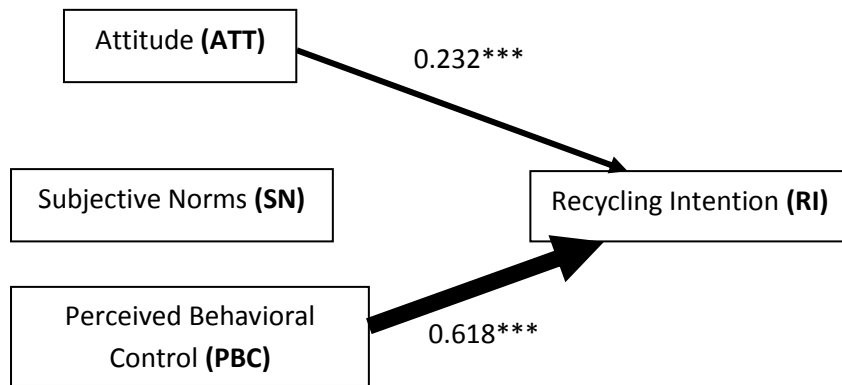

→ Significant ($p < 0.1$) direct positive effect

***: $p < 0.01$; **: $p < 0.05$; *: $p < 0.1$; R^2 (squared multiple correlation): 0.439

In Model B (Figure 6), the Attitude predictor is replaced by the Moral Norms' one. As it is showed, the moral norms' effect on RI is similar to Attitude's. Nevertheless, Model B explains less of the variance of RI ($R^2 = 0.427$ compared to 0.439) while it also fits somewhat worse the data (as exemplified by missing the RMSEA goodness-of-fit threshold). Therefore, the replacement of the 'Attitude' predictor with the 'Moral Norms' one has to be rejected.

Figure 6: Model B path analysis' results

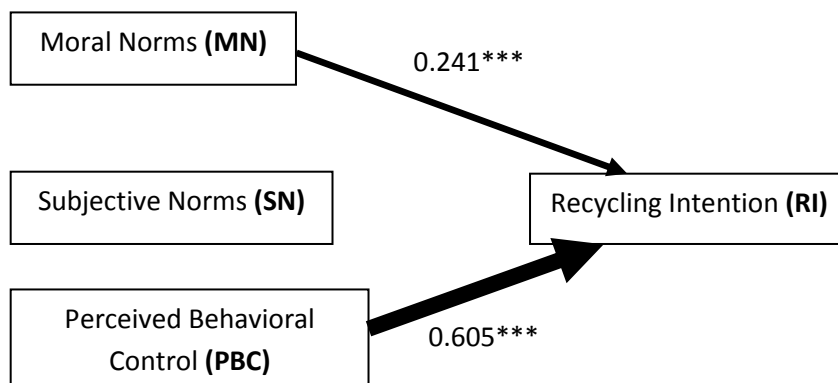

→ Significant ($p < 0.1$) direct positive effect

***: $p < 0.01$; **: $p < 0.05$; *: $p < 0.1$; R^2 (squared multiple correlation): 0.439;

Finally, Model C (Figure 7) tests the (in-)direct effect of moral norms on recycling intention. As it follows from the goodness-of-fit indices in Table 2, Model C fits the data almost as well as Model A, with both models explaining in effect the same amount of variance of the dependent variable (RI). Model C shows that Moral Norms have a substantial positive effect on Attitude, as anticipated by the theory. Yet, MN have also a noticeable and statistically significant direct effect on RI ($\gamma_{MN \rightarrow RI} = 0.152$, $p = 0.055$), which exceeds Attitude's. Furthermore, the MN's inclusion substantially reduces both the effect and the statistical significance of Attitudes ($\beta_{ATT \rightarrow RI} = 0.138$, $p = 0.088$). Finally, as it follows from Table 2 where the effects of the two models predictors' effects on RI are summarized, the MN effect on RI is *not* predominantly mediated through the ATT predictor (MN's indirect effect is statistically non significant), contrary to what has been suggested by previous research: three fifths of MN's total effect is direct, that is clear of any intervening standard TPB predictors.

Figure 7: Model C path analysis' results

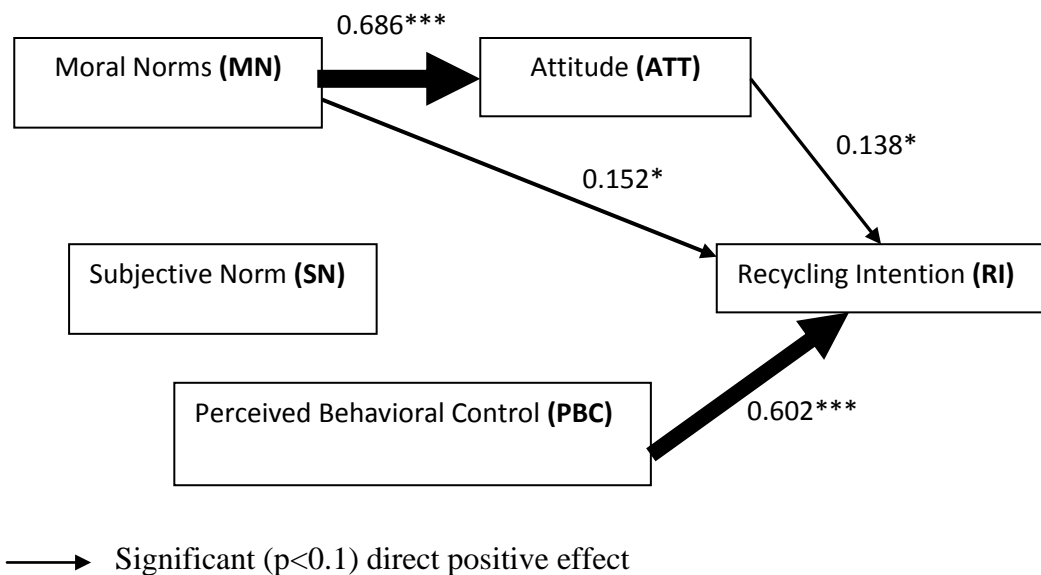

***: $p < 0.01$; **: $p < 0.05$; *: $p < 0.1$; R^2 (squared multiple correlation): 0.436.

Table 2: Effects analysis of an individual's recycling intention for Models A, B and C (based on the standardized path coefficients)

Latent variables/ Effects	Model A			Model B			Model C		
	Direct Effect (DE)	Indirect Effect (INDE)	Total Effect (TE=DE+INDE)	DE	INDE	TE	DE	INDE	TE
<i>Attitude</i>	0.232	--	0.232				0.138	--	0.138
<i>Subjective Norms</i>	n.s.	--	n.s.	n.s.	--	n.s.	n.s.	--	n.s.
<i>PBC</i>	0.618	--	0.618	0.605	--	0.605	0.602	--	0.602
<i>Moral Norms</i>				0.241	--	0.241	0.152	n.s.	0.246
Squared multiple correlation (R²)	0.439			0.427			0.436		
Goodness of fit indices (<i>in italics the accepted boundaries for close fit of the model</i>)									
RMSEA(0.0-0.1)	0.095			0.120			0.088		
GFI (≥0.85)	0.892			0.905			0.875		
AGFI (≥0.80)	0.858			0.863			0.839		
PGFI (≥0.50)	0.682			0.626			0.681		
Chi-square - χ^2	426.59 (p <0.001)			327.8 (p <0.001)			485.59 (p <0.001)		

n.s.: non statistically significant (p > 0.1)

4.2 The role of the demographic variables

As a second step, we include the demographic variables as further predictors. The Spearman's correlations between the various demographic predictors are reported in Table 3. The ensuing SEM models' estimation and depiction, as well as the reporting of the results, follow the same format of the ones described in the previous sub-section thus we will not repeat here.

Table 3: Spearman's correlation coefficients for the demographic predictors and the dependent variable (Recycling Intention)

	RI	Gender	Education	Age	Income
Recycling Intention (RI)	-				
Gender	n.s.	-			
Education	n.s.	n.s.	-		
Age	0.197***	-0.122**	n.s.	-	
Income	0.122**	-0.195***	0.217***	0.510***	-

***: Correlations are significant at a 1% level of significance;

** : Correlations significant at a 5% level of significance

In Figure 8, the results for the standard TPB model with the addition of the demographic predictors are presented (Model A1). As it is shown, the effect of the demographic variables is indirect, through the TPB predictors, as anticipated by the theory -save Income whose (direct or indirect) effect on RI is non significant. Nevertheless, for all the demographic predictors their total effect on RI is not statistically significant (see Table 4).

Figure 8: Model A1 path analysis' results

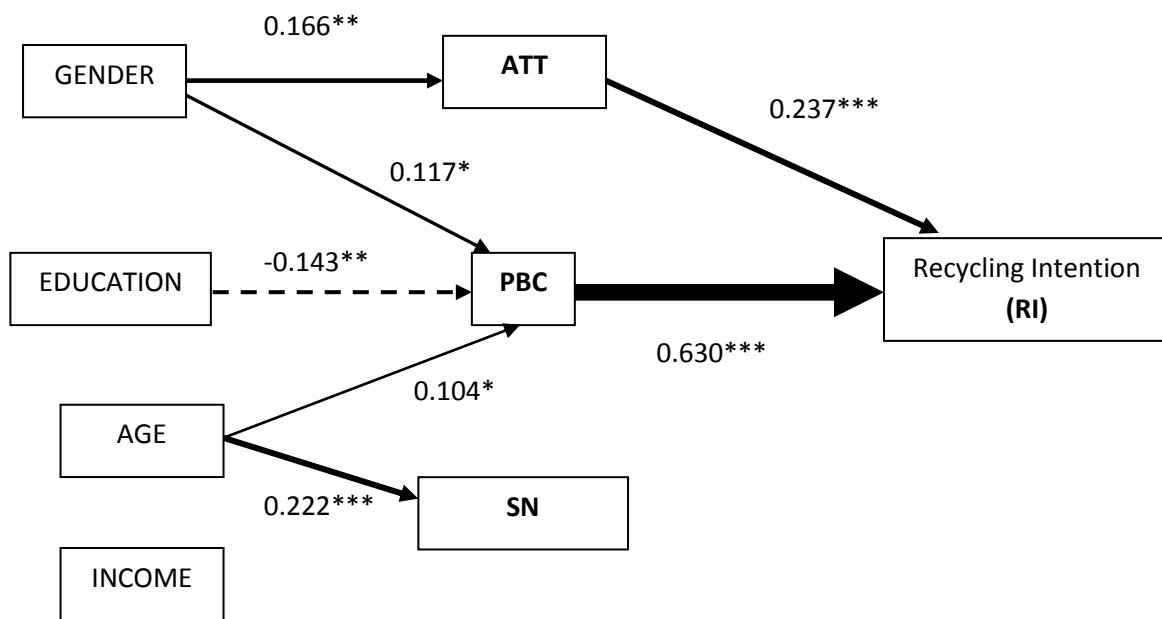

—→ Significant ($p < 0.1$) direct positive effect
 - - - - → Significant ($p < 0.1$) direct negative effect

***: $p < 0.001$; **: $p < 0.05$; *: $p < 0.1$; R^2 (squared multiple correlation): 0.451

Finally, based on the fits of Models B & C presented in the previous subsection, we will test an extended version of Model C: in this Model C1, the demographic variables are supposed to impact on RI both directly and indirectly - through the standard TPB predictors as well as the moral norms. The results are presented in Figure 9, and are quite similar to the ones of Model A1, as far as the demographic predictors are concerned: most of the latter influence RI only indirectly yet their overall effects are statistically non significant – save the ‘Gender’ predictor. Once again, the Moral Norms turned out to have a larger effect on RI than the

Attitude predictor. Also, similarly to what has been the case with Models A & C, the inclusion of Moral Norms fits the data equally well while it does not increase the explained variance between Models A1 & C1.

Figure 9: Model C1 path analysis' results

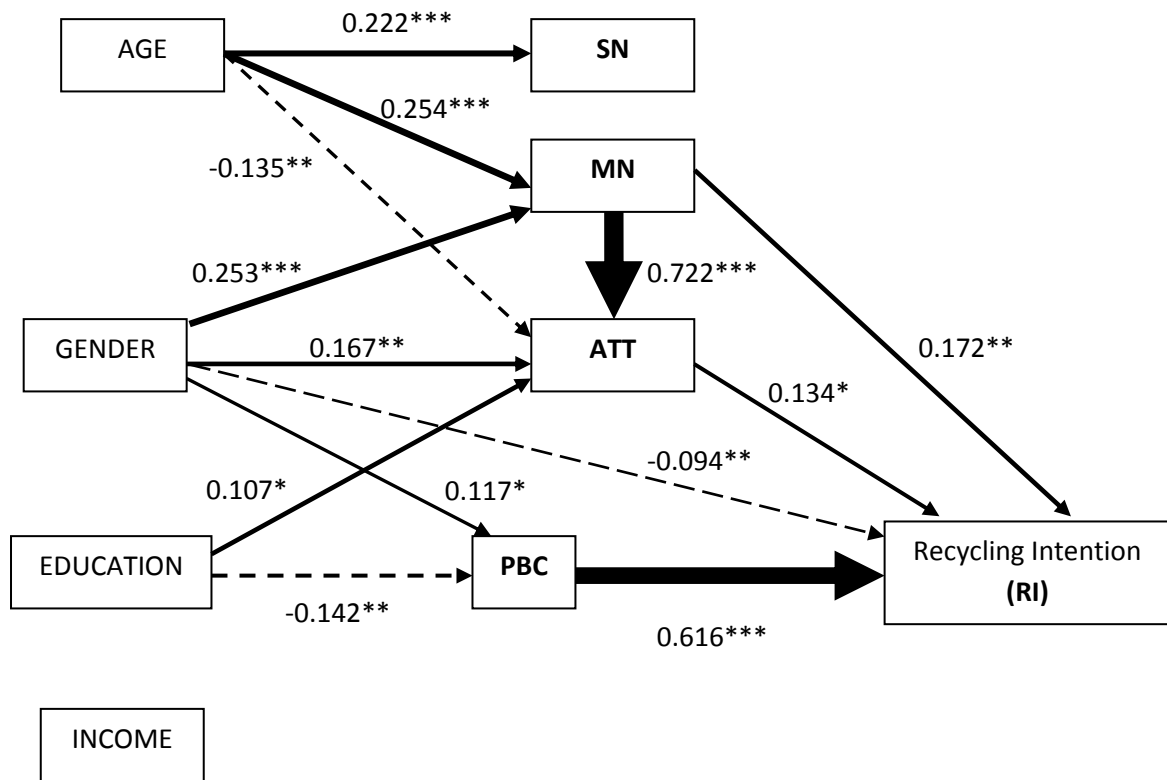

—→ Significant ($p < 0.1$) direct positive effect

- - - - → Significant ($p < 0.1$) direct negative effect

***: $p < 0.001$; **: $p < 0.05$; *: $p < 0.1$; R^2 (squared multiple correlation): 0.452;

Table 4: Effects analysis of an individual's recycling intention for Models A1 & C1 (based on the standardized path coefficients)

	Model A1			Model C1		
<i>Latent variables/ Effects</i>	Direct Effect (DE)	Indirect Effect (INDE)	Total Effect (TE=DE+INDE)	DE	INDE	TE
<i>Attitude</i>	0.237	--	0.237	0.134	--	0.134
<i>Subjective Norms</i>	n.s.	--	n.s.	n.s.	--	n.s.
<i>PBC</i>	0.630	--	0.630	0.616	--	0.616
<i>Gender</i>	n.s.	n.s.	n.s.	-0.094	0.137	0.042
<i>Education</i>	n.s.	n.s.	n.s.	n.s.	n.s.	n.s.
<i>Age</i>	n.s.	n.s.	n.s.	n.s.	n.s.	n.s.
<i>Income</i>	n.s.	n.s.	n.s.	n.s.	n.s.	n.s.
<i>Moral Norms</i>				0.172	n.s.	0.268
Squared multiple correlation (R²)	0.451			0.452		
Goodness of fit indices (<i>in italics the accepted boundaries for close fit of the model</i>)						
RMSEA (<i>0.0-0.1</i>)	0.090			0.085		
GFI (<i>≥0.85</i>)	0.871			0.872		
AGFI (<i>≥0.80</i>)	0.830			0.832		
PGFI (<i>≥0.50</i>)	0.660			0.664		
Chi-square - χ^2	591.66 (p <0.001)			648.5 (p <0.001)		

n.s.: non statistically significant (p > 0.1)

5. Discussion & Conclusions

This paper set out to examine whether the framework of the Theory of Planned Behavior (TPB) (Ajzen, 1991), one of the most commonly used theories in analyzing environmental behaviors, may be enhanced by the introduction of moral norms (MN) and of demographic variables as further predictors of recycling intention. More specifically, available research on the role of Moral Norms (MN) has been divided between those arguing that MN have a predominantly direct effect on behavioral intention, and thus it is largely unrelated to the standard TPB constructs, and those maintaining that its effect is largely indirect, and mediated through the Attitudes predictor. We are not aware of any study testing the middle road: namely, that MN impacts on recycling behavior both directly *and* indirectly-through Attitude:

thus, our research's first goal was to test this "middle-road" hypothesis. Concerning the role of demographics, it has been never tested empirically vis-à-vis the standard TPB constructs, let alone the Moral Norms predictor. Yet the predominant assumption is that the demographic characteristics' influence would be largely mediated through the psychological variables, and testing this assumption has been this paper's second goal.

In order to study and decompose the effects of the various predictor variables on an individual's willingness to recycle, we tested a number of structural models on data originating from Greece, concerning the intention to recycle through the "Blue Bin" system, a public and openly available curbside bin system operating throughout the country for almost fifteen years. We started with the standard TPB model (Model A), in which 'Attitude' (ATT), 'Perceived Behavioral Control' (PBC) and 'Subjective Norms' (SN) are the sole predictors of 'Recycling Intention' (RI). While all these predictors should have been found to be statistically significant, this has not been the case for SN, similar to another recent study about recycling in Greece (Ioannou *et al.*, 2013). Far from being an odd result (cf. Martin *et al.* (2006:362-363) and Thomas and Sharp (2013:14) for recent discussions of the SN's (lack of) significance in recycling), this finding is nevertheless puzzling since SN influence is supposed to be important *particularly* in a curbside recycling scheme, such as the 'Blue Bin' one, when one's behavior is performed in public and thus it is more open to societal scrutiny (cf. Barr *et al.*, 2003; Tucker, 1999).

An explanation of this puzzle may be offered by Schwartz (1977) who argued that social norms may be personally adopted and thus become internalized, 'personal moral' norms. In such a scenario, an individual will not e.g. be inclined to recycle because of any externally induced societal pressures and his/her willingness to conform with them but rather because of his/her personal inclination to do the right thing (cf. Hage *et al.*, 2009:156, 163). There exists ample evidence supporting this line of argument. While the Subjective Norms' operationalization in the Theory of Planned Behavior is basically a 'social injunctive norm' since it focuses on what significant others think of or approve concerning a behavior, White *et al.* (2009) showed that a 'social injunctive norm' is not a significant predictor of recycling intention/behavior: the social *milieu* influences an individual to recycle not so much through pressure but rather through example (i.e. what significant others *do* rather than what they *condone*) and through the construction of personal morally-relevant

norms (see also Fornara *et al.*, 2011) for a similar low effect of injunctive norms). Similarly, Biel and Thøgersen (2007), in their review of available research, note that '[studies] generally found that, although there was a significant and positive bivariate correlation between perceived social norms and behaviour, the correlation was strongly attenuated and in most cases became insignificant when personal [moral] norms were controlled' (p.104) while, and more particularly to recycling, Bratt (1999) found that SN impact only indirectly, through personal moral norms, on behavior. Arguably, this "internalization" of SN would need some time to occur, thus the SN's direct influence is more likely to be of lesser importance in the context of more mature recycling schemes (cf. Hage *et al.*, 2009:163; Davies *et al.*, 2002:39), such as the Greek 'Blue Bin' one. Evidence to this is provided by Vining *et al.* (1992) who, in their comparison of four USA communities, found that the lowest mean importance rating for social influences on recycling behavior was given by residents of that very community which has had the most visible and inclusive, as well as the longer running, curbside recycling program, leading the authors to conclude that '[those] residents, having the most experience with recycling, have simplified their recycling rationale into [...] a binary structure over time, altruistic reasons and unimportant reasons [...] while...' The third factor, social influence, accounted for only a very small proportion of the variance, and was rated as unimportant as well' (p.795).

The previous discussion points to the importance of examining the role Moral Norms (MN) play in recycling intention, the first goal of the present study. In accordance to the ongoing theoretical debate, we tried to establish whether MN should be treated as a substitute of the Attitude (ATT) predictor (Model B) or as a prior variable, impacting on both ATT and Recycling Intention (Model C). Our results did not support the former hypothesis, with Model B explaining less variance of the dependent variable as well as failing the RMSEA goodness-of-fit criterion (see Table 2). On the contrary, Model C explains and fits the data as well as (the standard TPB) Model A. Yet, Model C offers some interesting qualitative clues concerning the role of MN in recycling. In accordance with theoretical expectations and previous research, MN was found to be modestly correlated with Attitude (ATT) (Pearson's $r = 0.583$). Yet, contrary to the commonly held view, MN's impact on Recycling Intention is largely direct, that is independent of ATT, and also more substantial than Attitude's ($\gamma_{MN \rightarrow RI} = 0.152$ vs. $\beta_{ATT \rightarrow RI} = 0.138$, see Table 2). Furthermore, the indirect effect of MN to RI (through ATT) was found to be statistically non significant, again

contrary to what has been theorized. While the moderate correlation between MN and ATT is supported by recent research (Chen and Tung, 2010; Chan and Bishop, 2013), this has raised the question whether it is due to the fact that certain of the Attitude's scale variables (i.e. 'recycling is: *bad/good; responsible/responsible*') may be overlapping with Moral Norms. Thus, when Chan and Bishop (2013) reran their analyses -after removing these items- they found that, while their model's fit remained good, the correlation between MN and the reduced ATT predictors *increased*, signaling a lack of discriminant validity between the two concepts. In order to check this, we also re-run Models A & C excluding the morally-loaded questions, and this returned modified Models A⁻ and C⁻ (see Table X2 in the Appendix). Contrary to Chan and Bishop (2013), our own re-runs returned a small reduction of the Pearson's r correlation coefficient (from 0.583 to 0.484) between the modified Attitude and Moral Norms predictors, suggesting that they are distinct concepts, each encapsulating a different assessment of recycling behavior (cf. Manstead, 2000), while the modified Models' A⁻ & C⁻ explained variance decreased. The fact that this decrease is more pronounced for Models A & A⁻ offers further evidence to the importance of moral considerations in recycling intention. Furthermore, it is worth noting that Attitude's direct effect on RI becomes statistically non significant in the modified Model C⁻ (see Table X2), further highlighting the fact that, for the Greek sample, payoff considerations (i.e. 'recycling is: *a waste of time/useful; not rewarding/rewarding; not hygienic/hygienic*') are much less important than a perception of recycling as the (morally) "right-thing-to-do".

Since Chen and Tung (2010) and Chan and Bishop (2013) operationalized the Moral Norms' predictor differently than this study, it is important that we compare our findings with similarly-structured research. While using a MN construct same to ours, Kaiser and Scheuthle (2003) found that adding the MN as a fourth, independent predictor does not improve the predictiveness of the standard TPB model regarding the (intention of) performing a 6-items, aggregate, "conservation behavior" (including recycling) (pp. 1039-1040). This was also the case in a paper analyzing a number of energy-curtailment behaviors (Botetzagias *et al.*, 2014:420) and it resurfaces in the present study (compare Models A/A⁻ to models C/C⁻, in Tables 2 and X2). Nevertheless, our other findings differ drastically. Thus Kaiser and Scheutle (2003:1039), as well as Kaiser (2006:77) who studied a compound 'General Ecological Behavior Scale', found that MN has a negative direct effect on Intention,

contrary to our finding of a positive direct effect. Furthermore, Kaiser (2006:79) reported a lack of discriminant validity between MN and Attitude, again contrary to our results. How are these differences to be explained? A plausible argument is that they are due to the different behaviors analyzed in the aforementioned studies. In particular, our 'recycling in the Blue Bin' behavioral intention is a very different beast than Kaiser and Scheutle's (2003) aggregate factor of behaviors, ranging from '*I collect and recycle used paper*' to '*when I see someone behaving unecologically, I point it out to him or her*': each of the latter is very likely to entail/evoke quite different moral considerations and this would affect the overall MN's performance and influence (Chan and Bishop (2013:97) also raise the same concern). In other words, the specific formulation of the various predictors/variables as well as the particular behavior to be analyzed, both have significant repercussions on the results obtained. A juxtaposition of the results reported by Tonglet et al. (2004) and Davis *et al.* (2006), on the one hand, and Chen and Tung (2010), on the other hand, concerning the influence of moral norms on recycling intention, is instructive to this effect. The former two studies, while using a 5-items 'moral norms' scale, report a statistically non-significant influence; on the contrary, Chen and Tung (2010), employing only three of the original five 'moral norms' items, find a statistically-significant effect of MN on recycling intention.

As a final step, we tested the effect of demographic variables on recycling intention, including them as prior variables both in the standard TPB model (Model A1) as well as in its morally-extended version (Model C1). Our results corroborate previous findings: the demographic variables contribute very little to the explained variance of RI while their influence is much weaker than the psychological predictors' and largely indirect, mediated through the TPB-Moral variables, as argued by (Ajzen and Fishbein, 1980). Overall, demographic variables were found to be statistically non significant predictors of RI, with the exception of Gender whose total effect is nevertheless miniscule (0.042, see Table 4).

Overall, the most important predictor of recycling intention was the Perceived Behavioral Control (PBC) one feels s/he have over the behavior. This is hardly surprising if one considers that the "Blue Bin" is a very easily accessible scheme: there is no need to separate your recyclables, the "Blue Bins" are to be found in almost every street and most usually they are placed next to the "Green Bins" -where one casually deposits all his/hers other household waste- while the fact that they are

placed in public view serves as a constant reminder that an operational recycling scheme is readily at hand. This result is consistent with most recent research (e.g. Ioannou *et al.* 2013; White *et al.* 2009; Barr 2007; Knussen *et al.* 2004; *contra* Chen and Tung 2010).

The second most important predictor turned out to be Moral Norms, over and independently of one's Attitude towards recycling. This result, in conjunction with the non significant impact of Subjective Norms, suggests that, for the Greek context, the intention to recycle is based on an internalized, personal, feeling of moral obligation to 'do-what-feels-right' and not on some need to conform with social standards and to avoid social injunctions. This result corroborates the increasing body of available research which argues that MN is a necessary, and conceptually distinct, addition to the standard TPB framework. That said, it should also be noted that MN's relative importance and specific operation within that framework may be contingent to the larger context in which a behavior occurs. Thus, the existence of an easily accessible curbside recycling scheme, such as the 'Blue Bin', is likely to moderate the effect of any 'cost-and-benefit' (Attitude's predictor) considerations on intention. Likewise, a long-standing recycling scheme, in tandem with a sustained educational and informational campaign on the need to recycle -as it has been the case in Greece-, makes it more likely that individuals would have had the time to internalize any societal effects and develop a personal 'Moral Norm' towards performing the behavior, thus rendering any considerations of societal scrutiny and injunction (the Subjective Norms' predictor) irrelevant.

Before concluding, we would like to discuss the possible limitations of our study. In the 'Context and Sample' sub-section we have already mentioned the possible bias introduced by the self-selection process in our sampling, which arguably would have weakened the existing correlations. Nevertheless, similar to Chan and Bishop (2013) who employed an analogous research format, this has not been the case: our analyses returned overall statistically significant relationships between the variables as well as congruent with what has been theoretically expected. Furthermore, our results are similar to Ioannou *et al.*'s (2013) who, while analyzing a convenience sample of 357 households in the Greater Athens area (Greece), also found statistically non-significant influences for Social Norms and demographic characteristics -contrary to Attitude's and PBC's significant effects (these authors had not included Moral Norms as a predictor in their study). Thus, and while we

acknowledge the limitations posed by the specific characteristics of our sample which should serve as a note of caution as far as the interpretation of our results is concerned, it is rather unlikely that the sample's composition substantially affected the results obtained. Another limitation of our results is the border-line fit of the models tested. A number of reasons may account for this result. Thus, the inclusion of paths which turned out to be not statistically significant (e.g. the paths from Social Norms (and from Income) to Recycling Intention (and to the standard TPB predictors)) and/or technical SEM assumptions which do not necessarily hold in the real world (i.e. for our analysis we assumed that the errors associated with the observed variables are uncorrelated) may all reduce a model's fit. Arguably, we could have improved the fit through the models' post hoc re-specification, following the modification indexes provided by the software program. Nevertheless, this research's goal was not to establish the best, re-fitted, model concerning recycling behavior but rather to test a number of, theory-informed, concept models. To this end, the (border-line) fit of the various models tested points both to the potential as well as to the limitations of expanding the standard TPB with the inclusion of further predictors.

Finally, besides its predominant theoretical focus, this paper also offers some policy-related insights. The first is that demographic characteristics are a very weak and quite insignificant predictor of recycling intention. It seems that, in Greece, recycling is practiced by all socio-demographic strata, thus focused policy-interventions (i.e. targeting, for example, the elderly, the less educated and so on, citizens) are not necessary. The strong influence of the Perceived Behavioral Control (PBC) predictor on Intention points towards the further development, and expansion, of the existing "Blue Bin" curbside system as the easiest, and most effective way, of increasing recycling rates. Lastly, the moderate total effect of Moral Norms on RI, as well as their strong influence on ATT, suggests that promoting/advertizing recycling as the morally "right" thing to do when it comes to domestic waste disposal, is also likely to spur an individual to (further) engage with it.

Appendix

Table X1: Sample's demographic characteristics

Demographic Variables	Percentages
Gender	
Male	39.6
Female	59.4
Age	
Younger than 20 y.o.	2.4
20-35 y.o.	63.1
36-50 y.o.	28.0
Older than 50 y.o.	6.1
Annual Available Income	
Up to 10,000€	49.8
10,001 - 40,000€	43.7
Over 40,000€	4.1
Educational Attainment <i>(achieved/currently studying)</i>	
High school or lower	10.9
University degree	36.9
M.Sc. degree	37.5
Ph.D. degree	13.7

Table X2: AMOS results for modified ATTITUDE predictor (i.e. excluding morally-loaded questions): Model A⁻ (standard TPB model) and Model C⁻ (moral norms impacting on attitude and recycling intention)

AMOS path coefficients	Model A⁻	Model C⁻
Attitude → Intention	0.224***	n.s.
Subjective Norms → Intention	n.s.	n.s.
PBC → Intention	0.528***	0.602***
Moral Norms → Intention		0.188**
Moral Norms → Attitude		0.662***
R^2 (Squared multiple correlation)	0.329	0.427
RMSEA (0.0-0.1)	0.079	0.099
GFI (≥ 0.85)	0.896	0.902
AGFI (≥ 0.80)	0.854	0.867
PGFI (≥ 0.50)	0.640	0.663
Chi-square - χ^2	387.9 (p < 0.001)	387.9 (p < 0.001)

***: p < 0.01; **: p < 0.05; *: p < 0.1

References

- Abrahamse, W., Steg, L., 2011.** Factors related to household energy use and intention to reduce it: the role of psychological and socio-demographic variables. *Human Ecology Review* 18 (1), 30.
- Ajzen, I., 1985.** From intentions to actions: A theory of planned behaviour. In J. Kuhl & J. Beckmann (Eds), *Action-control: From cognition to behaviour*, 11-39. Heidelberg : Springer.
- Ajzen, I., 1991.** The theory of planned behavior. *Organizational Behavior and Human Decision Processes* 50 (2), 179-211.
- Ajzen, I., 2002.** Constructing a TpB Questionnaire: Conceptual and Methodological Considerations. Revised version, 2006. Retrieved from: <http://people.umass.edu/aizen/pdf/tpb.measurement.pdf>, accessed August 4, 2014
- Ajzen, I. and Fishbein, M., 1980.** Understanding Attitudes and Predicting Social Behavior. Englewood Cliffs, NJ: Prentice Hall.
- Arbuckle, J.L., 2006.** Amos 7.0 User's Guide. Chicago, IL: SPSS.
- Bamberg, S. and Moser, G., 2007.** Twenty years after Hines, Hungerford, and Tomera: A new meta-analysis of psycho-social determinants of pro-environmental behaviour. *Journal of Environmental Psychology* 27 (1), 14-25.
- Barr, S., Ford, N.J. and Gilg, A.W., 2003.** Attitudes towards Recycling Household Waste in Exeter, Devon: Quantitative and qualitative approaches. *Local Environment* 8 (4), 407-421.
- Bezzina, F.H. and Dimech, S., 2011.** Investigating the determinants of recycling behaviour in Malta. *Management of Environmental Quality: An International Journal* 22 (4), 463-485.
- Biel, A. and Thøgersen, J., 2007.** Activation of social norms in social dilemmas: A review of the evidence and reflections on the implications for environmental behaviour. *Journal of Economic Psychology* 28 (1), 93-112.
- Boldero, J., 1995.** The Prediction of Household Recycling of Newspapers: The Role of Attitudes, Intentions, and Situational Factors. *Journal of Applied Social Psychology* 25 (5), 440-462.
- Botetzagias, I., Malesios, C. and Poulou, D., 2014.** Electricity curtailment behaviors in Greek households: Different behaviors, different predictors. *Energy Policy* 69, 415-424.
- Bratt, C., 1999.** The Impact of Norms and Assumed Consequences on Recycling Behavior. *Environment and Behavior* 31 (5), 630-656.
- Chan, K., 1998.** Mass communication and pro-environmental behaviour: waste recycling in Hong Kong. *Journal of Environmental Management* 52, 317-325.
- Chan, L. and Bishop, B., 2013.** A moral basis for recycling: Extending the theory of planned behavior. *Journal of Environmental Psychology* 36, 96-102.
- Chen, M.-F. and Tung, P.-J., 2010.** The Moderating Effect of Perceived Lack of Facilities on Consumers' Recycling Intentions. *Environment and Behavior* 42 (6), 824-844.

- Cheung, S.F., Chan, D.K.-S. and Wong, Z.S.-Y., 1999.** Reexamining the Theory of Planned Behavior in Understanding Wastepaper Recycling. *Environment and Behavior* 31 (5), 587-612.
- Chowdhury, S. and Ceder, A., 2013.** A Psychological Investigation on Public-transport Users' Intention to Use Routes with Transfers. *International Journal of Transportation* 1 (1), 1-20.
- Christian, J., Armitage, C.J. and Abrams D., 2007.** Evidence That Theory of Planned Behaviour Variables Mediate the Effects of Socio-demographic Variables on Homeless People's Participation in Service Programmes. *Journal of Health Psychology* 12 (5), 805–817. DOI: 10.1177/1359105307080615
- Davies, J., Foxall, G.R. and Pallister, J., 2002.** Beyond the Intention-Behaviour Mythology: An Integrated Model of Recycling. *Marketing Theory* 2 (1), 29-113.
- Davis, G., Phillips, P.S., Read, A.D. and Iida, Y., 2006.** Demonstrating the need for the development of internal research capacity: Understanding recycling participation using the Theory of Planned Behaviour in West Oxfordshire, UK. *Resources, Conservation and Recycling* 46, 115–127.
- Eluwa, S. E. and Siong, H.C., 2013.** The impact of psychological and socio-economic variables on household energy conservation: A case study of Ibadan city, Nigeria. *ARPN Journal of Earth Sciences* 2 (3), 81-89.
- Fishbein, M., 1967.** Attitude and the prediction of behavior. In M. Fishbein (Ed.), *Readings in attitude theory and measurement* (477-492). New York, NY John Wiley & Sons.
- Fornara, F., Carrus, G., Passafaro, P. and Bonnes, M., 2011.** Distinguishing the sources of normative influence on proenvironmental behaviors: The role of local norms in household waste recycling. *Group Processes & Intergroup Relations* 14 (5), 623-635.
- Hage, O., Soederholm, P. and Berglund, C., 2009.** Norms and economic motivation in household recycling: Empirical evidence from Sweden. *Resources, Conservation and Recycling* 53 (3), 155-165.
- Harland, P., Staats, H. and Wilke, H.A.M., 1999.** Explaining Proenvironmental Intention and Behavior by Personal Norms and the Theory of Planned Behavior. *Journal of Applied Social Psychology* 29 (12), 2505-2528.
- HERRCO (2013),** Hellenic Recovery Recycling Corporation. Retrieved from: <http://www.herrco.gr/>, accessed August 4, 2014
- Hu, L. and Bentler, P.M., 1999.** Cutoff criteria for fit indexes in covariance structure analysis: Conventional criteria versus new alternatives, *Structural Equation Modeling*, 6(1), 1-55.
- Ioannou, T., Zampetakis, L. A. and Lasaridi, K., 2013.** Psychological determinants of household recycling intention in the context of the Theory of Planned Behaviour. *Fresenius Environmental Bulletin* 22 (7A), 2035-2041.
- Kaiser, F.G., 2006.** A moral extension of the theory of planned behavior: Norms and anticipated feelings of regret in conservatism. *Personality and Individual Differences* 41, 71–81.

- Klockner, C.A.**, 2013. A comprehensive model of the psychology of environmental behavior - A meta-analysis. *Global Environmental Change* Article in Press.
- Knussen, C, Yule, F, MacKenzie, J and Wells, M.**, 2004. An analysis of intentions to recycle household waste: The roles of past behaviour, perceived habit, and perceived lack of facilities. *Journal of Environmental Psychology* 24 (2), 237-246.
- Knussen, C. and Yule, F.**, 2008. I'm Not in the Habit of Recycling: The Role of Habitual Behavior in the Disposal of Household Waste. *Environment and Behavior* 40 (5), 683-702.
- Kollmuss, A. and Agyeman, J.**, 2002. Mind the Gap: Why do people act environmentally and what are the barriers to pro-environmental behavior?. *Environmental Education Research* 8 (3), 239-260.
- Mannetti, L., Pierro, A. and Livi, S.**, 2004. Recycling: Planned and self-expressive behaviour. *Journal of Environmental Psychology* 24, 227–236.
- Manstead, A.S.R.**, 2000. The role of moral norm in the attitude-behavior relation. In Terry, J.D. and Hogg, M.A. (eds) *Attitudes, behavior and social context. The role of norms and group membership*. Mahwah, NJ: Lawrence Erlbaum
- Martin, M., Williams, I. D. and Clark, M.**, 2006. Social, cultural and structural influences on household waste recycling: A case study. *Resources, Conservation and Recycling* 48 (4), 357-395.
- Nigbur, D., Lyons, E. and Uzzell, D.**, 2010. Attitudes, norms, identity and environmental behaviour: Using an expanded theory of planned behaviour to predict participation in a kerbside recycling programme. *British Journal of Social Psychology* 49, 259–284.
- Ramayah, T., Lee, J. W. C. and Lim, S.**, 2012. Sustaining the environment through recycling: An empirical study. *Journal of Environmental Management* 102, 141-147.
- Schwartz, S.H.**, 1977. Normative influence on altruism. *Advances in Experimental Social Psychology* 10, 221–279.
- Thomas, C. and Sharp, V.**, 2013. Understanding the normalisation of recycling behaviour and its implications for other pro-environmental behaviours: A review of social norms and recycling. *Resources, Conservation and Recycling* 79 (0), 11-20.
- Tonglet, M., Phillips, P.S. and Read, A.D.**, 2004. Using the Theory of Planned Behaviour to investigate the determinants of recycling behaviour: a case study from Brixworth, UK. *Resources, Conservation and Recycling* 41, 191–214.
- Tucker, P.**, 1999. Normative Influences in Household Waste Recycling. *Journal of Environmental Planning and Management* 42 (1), 63-82.
- Turaga, R.M., Howarth, R.B. and Borsuk, M.E.**, 2010. Pro-environmental behavior: Rational choice meets moral motivation. *Annals of the New York Academy of Sciences* 1185 (1), 211-224.
- Vining, J., Linn, N. and Burdge, R.**, 1992. Why recycle? A comparison of recycling motivations in four communities. *Environmental Management* 16 (6), 785-797.
- White, K.M., Smith, J.R., Terry, D.J., Greenslade, J.H. and McKimmie, B.M.**, 2009. Social influence in the theory of planned behaviour: The role of descriptive, injunctive, and in-group norms. *British Journal of Social Psychology* 48 (1), 135-158.