

**Original citation:**

Kalvala, Sara, Warburton, Richard and Lacey, David (2008) Program transformations using temporal logic side conditions. Coventry, UK: Department of Computer Science. CS-RR-439

**Permanent WRAP url:**

<http://wrap.warwick.ac.uk/60541>

**Copyright and reuse:**

The Warwick Research Archive Portal (WRAP) makes this work by researchers of the University of Warwick available open access under the following conditions. Copyright © and all moral rights to the version of the paper presented here belong to the individual author(s) and/or other copyright owners. To the extent reasonable and practicable the material made available in WRAP has been checked for eligibility before being made available.

Copies of full items can be used for personal research or study, educational, or not-for-profit purposes without prior permission or charge. Provided that the authors, title and full bibliographic details are credited, a hyperlink and/or URL is given for the original metadata page and the content is not changed in any way.

**A note on versions:**

The version presented in WRAP is the published version or, version of record, and may be cited as it appears here. For more information, please contact the WRAP Team at: [publications@warwick.ac.uk](mailto:publications@warwick.ac.uk)

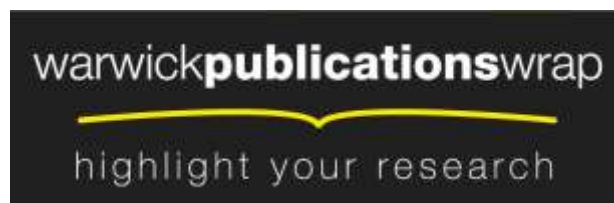

<http://wrap.warwick.ac.uk/>

# Program transformations using temporal logic side conditions

Sara Kalvala and Richard Warburton  
University of Warwick

David Lacey  
XMOS Semiconductor

August 22, 2008

## Abstract

This paper describes an approach to program optimisation based on transformations, where temporal logic is used to specify side conditions, and strategies are created which expand the repertoire of transformations and provide a suitable level of abstraction. We demonstrate the power of this approach by developing a set of optimisations using our transformation language and showing how the transformations can be converted into a form which makes it easier to apply them, while maintaining trust in the resulting optimising steps. The approach is illustrated through a transformational case study where we apply several optimisations to a small program.

## 1 Introduction

Significant effort in modern compiler development is spent implementing *optimisations*, which are often performed after an initial synthesis of low-level code [ALSU07, App98, Muc97]. Optimisations are often classified as either *local* or *global*. Local optimisations transform small segments of code, typically by pattern matching and simple rewriting, while global optimisations exploit complex chains of information and subtle patterns of execution. While such global optimisations are often difficult to identify in a program, the payback is sufficient to motivate development of general and robust techniques to incorporate them into working compilers. Furthermore, the complexity of the conditions at which some global optimisations apply implies that significant care has to be taken to ensure that they are not applied in a way that introduces errors in the program. Thus, a precise, formal language for specifying these global optimisations is a very useful addition to the arsenal of compiler designers.

The *rewriting* paradigm is particularly appropriate for describing optimisations, as rewrites express the transformation of the program and can usually be specified succinctly and intuitively, with side conditions that describe when the rewrite may be applied. In the case of local optimisations, side conditions

can be relatively easy to specify as they are purely syntactic. For global optimisations the situation is more complex, particularly for programs written in imperative languages, as the conditions under which it is possible to apply rewrites are harder to describe—they often depend on capturing some or all the paths of execution through the program. Their specification needs to model semantic information, which is not always easy to track, particularly when dealing with the low-level representation of programs to which they are applied. The obvious solution is to employ a rigorous language for expressing optimisations that supports formal reasoning. However, such a language often raises the issue about its actual applicability to realistic tasks: ‘toy’ languages often carry the risk of not supporting the kinds of complex operations that practitioners would actually like to perform with them. An effective tool to aid optimisation needs to blend expressivity and rigour.

In this paper we propose a specification language for transformations capable of capturing many transformations found within optimising compilers for imperative languages. The transformations apply to *control flow graphs*, which represent the temporal nature of the program. We claim that the language is expressive enough to capture a variety of optimisations, and we support this claim by presenting a catalogue of optimisations expressed in the language described. The transformations described range from simple ones such as dead code elimination (which checks if the result of a computation will ever be used later in the program’s execution, see Section 8.1), and more complex ones such as lazy code motion (which moves a computation to a different point in the program to eliminate unnecessary calculations in loops, see Section 9.4). Other transformations described in our framework include constant propagation, strength reduction, branch elimination, skip elimination, loop fusion, partial redundancy elimination, and lazy strength reduction.

It is not enough to have a library of very well understood and trusted optimisations: practitioners often design complex, new optimisations to improve compilers for particular applications, and methodologies that can support such development are very useful. In Section 5 we show how new transformations can be assembled to implement special optimisations which arise while manipulating a specific piece of code. The formal underpinning of the language aids the verification of the soundness of such new transformations expressed in it.

Key to our approach is the blending of ideas from rewriting and temporal logic, which can aid reasoning about the soundness of the optimisations. We have based the language of side conditions on CTL, a well-understood and widely used temporal logic that allows side conditions to be checked mechanically against the representation of a program. Furthermore, as the program to be optimised is expressed in a language with a formal semantics, the soundness of the transformations can also be proved rigorously, as has been shown previously [LJWF02, LJWF04]. We maintain that the methodology described here supports the development of transformations, reasoning about the correctness of the transformations, and application of these transformations to programs to be optimised.

The structure of this paper is as follows: Section 2 introduces a simple

$instr ::=$ <ul style="list-style-type: none"> <li><code>skip</code></li> <li><code>var := expr</code></li> <li><code>if expr goto num</code></li> <li><code>goto num</code></li> <li><code>ret(expr)</code></li> </ul>	$expr ::=$ <ul style="list-style-type: none"> <li><code>expr op expr</code></li> <li><code>num</code></li> <li><code>var</code></li> </ul> $num ::=$ <code>..., -2, -1, 0, 1, 2, ...</code> $var ::=$ <code>x, y, z, ...</code> $op ::=$ <code>+, ×, -, ...</code>
---	---

Figure 1: Grammar for instructions in the  $L_0$  programming language

programming language over which the transformations operate and the representation of programs through control flow graphs. Section 3 explains the background to the design of the transformation specification language while Section 4 describes the syntax of the language. A case study showing how transformations can be formulated is discussed in Section 5, while Section 6 describes the semantics of the language in detail. We describe how the approach is used to identify loops within programs through an example of dominator analysis in Section 7. Transformation specifications are described in Section 8 and Section 9. We then show how the process of applying transformations can be mechanised in Section 10, and a discussion of the limitations of our approach is presented in Section 11. In Section 12 we survey related work and finally add some concluding remarks in Section 13.

## 2 The Source Language

### 2.1 The $L_0$ programming language

The methodology for specifying transformations in this paper applies to a variety of languages; we introduce a simple imperative language  $L_0$  to aid presentation. This toy language is standard in its behaviour; a formal semantics for  $L_0$  can be found elsewhere [Lac03]. The language is meant to exemplify compiler intermediate representations rather than programming languages, since that is the level at which optimisations are usually applied. Some features of even low-level programming languages, such as function calls, exceptions, input/output statements and pointers, have not been included in  $L_0$ . Control structures are written using jump statements instead of looping constructs. We assume the instructions are labelled; if a `goto` or conditional statement refers to an instruction label greater than the length of the program then control jumps to the last instruction.

An  $L_0$  program consists of a sequence of instructions where an instruction can take one of five typical forms.

**Definition 2.1** *An  $instr$  is a single command of the form given in Fig. 1.*

	0: i := 0
	1: if (i < 10) goto 14
var i : integer;	2: temp1 := 1 * 1
var a : array 10 of array 3 of integer;	3: temp2 := i * 3
	4: temp3 := 1 + temp2
begin	5: temp4 := temp3 + temp1
i := 0;	6: M[temp4] := 0
while i < 10 do	7: temp5 := 2 * 1
a[i][1] := 0;	8: temp6 := i * 3
a[i][2] := 0;	9: temp7 := 1 + temp6
i := i + 1	10: temp8 := temp7 + temp5
end;	11: M[temp8] := 0
end.	12: i := i + 1
	13: goto 1
	14: ret 0

Figure 2: An example program in Pascal and its translation into  $L_0$

**Definition 2.2** A program of length  $n$  ( $n \geq 1$ ) is a list  $I_0, \dots, I_{n-1}$  of instructions, where instruction  $I_{n-1}$  is the only instruction of the form  $\mathbf{ret}(e)$ .

An example program in  $L_0$ , corresponding to a small Pascal program which clears two lines of an array, is presented in Fig. 2.

## 2.2 The control flow graph

The transformation approach introduced in this paper relies on the representation of programs as *control flow graphs* (CFGs), where each node corresponds to an individual instruction in the program, except for designated *Entry* and *Exit* nodes. The edges between nodes represent *possible* steps in the program between the instructions. In order to facilitate transformations, labels are added to edges of CFGs: edges that result from the condition in a conditional statement being true are labelled *branch*, and all other edges are labelled *seq* to signify default sequential execution. Fig. 3(b) shows an example CFG.

Formally, a CFG is defined as a triple consisting of a set of nodes, an edge relation and a labelling function which labels each node with an instruction.

**Definition 2.3** A CFG for a program  $I_0, \dots, I_{n-1}$  is the tuple  $\langle \text{Nodes}, \text{Edges} \subseteq \text{Nodes} \times \text{Nodes} \times \{\text{seq}, \text{branch}\}, I : \text{Nodes} \rightarrow \text{Instr} \rangle$  where:

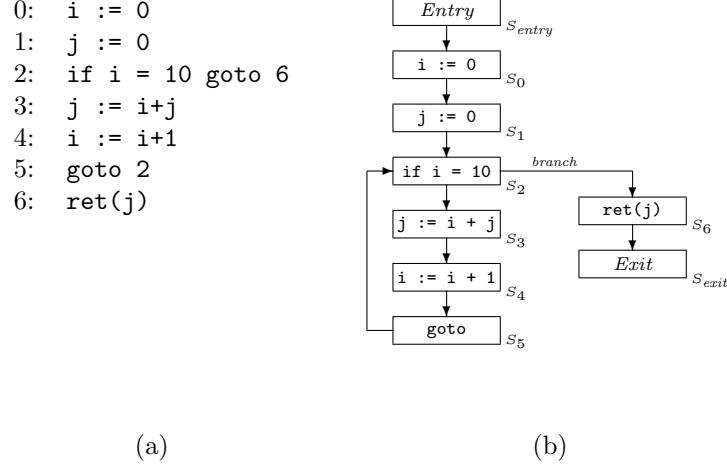

Figure 3: A program in  $L_0$  and its control flow graph

$$\begin{aligned}
\text{Nodes} &= \{Entry, N_0, \dots, N_{n-1}, Exit\} \\
\text{Edges} &= \{(Entry, N_0, seq), (N_{n-1}, Exit, seq)\} \\
&\cup \{(N_i, N_{i+1}, seq) \mid I(N_i) \neq \text{goto } -, 0 \leq i < n-1\} \\
&\cup \{(N_i, N_j, branch) \mid 0 \leq i < n, 0 \leq j < n, I(N_i) = \text{if } e \text{ goto } j\} \\
&\cup \{(N_i, N_{n-1}, branch) \mid 0 \leq i < n, j < 0 \vee j \geq n, I(N_i) = \text{if } e \text{ goto } j\} \\
&\cup \{(N_i, N_j, seq) \mid 0 \leq i < n, 0 \leq j < n, I(N_i) = \text{goto } j\} \\
&\cup \{(N_i, N_{n-1}, seq) \mid 0 \leq i < n, j < 0 \vee j \geq n, I(N_i) = \text{goto } j\} \\
I(N) &= \begin{cases} I_i & \text{if } N = N_i, \\ \text{skip} & \text{otherwise} \end{cases}
\end{aligned}$$

All CFGs that are referred to within this paper have the additional property of *recoverability*. A CFG is said to be *recoverable* if:

- only one node is associated with a **ret** instruction and this is the only node whose successor is the *Exit* node;
- the *Entry* node has no predecessors;
- the *Exit* node has no successors;
- any node associated with a conditional has exactly two successors, one edge of type *seq* and one of type *branch*;
- any node not associated with a conditional has exactly one successor connected by an edge of type *seq* (apart from the *Exit* node).

Recoverability is a useful property since the transformation methodology described here performs transformations on the CFG rather than the program itself, and one would like to recover a program in  $L_0$  from the generated CFG. Recoverability simplifies the process of converting a transformed CFG back into an  $L_0$  program. In our work recoverability is preserved by ensuring that a transformation is not applied if any of the above properties are violated by the resulting CFG.

### 2.3 Paths through a control flow graph

The transformations introduced in Section 4 use side conditions which describe properties about *complete paths* through a program. Complete paths from a specified point  $n$  are sequences of connected nodes through a CFG from point  $n$  to the *Exit* point. Accordingly, complete paths can be extracted from a CFG using the following definition:

**Definition 2.4** *For a CFG  $\mathcal{G}$ , the set of complete paths of a system from a state  $n_0$  is denoted  $CPaths(n_0, \mathcal{G})$  and consists of all finite sequences  $n_0 n_1 \dots n_k$  such that  $n_i \rightarrow n_{i+1}$ , for all  $n_i$  with  $i < k$  and such that there does not exist a  $n_{k+1}$  such that  $n_k \rightarrow n_{k+1}$ . The notation  $x \rightarrow y$  is used when  $\exists(n, m, -) \in Edges | n = x, m = y$ .*

### 2.4 Limitations of $L_0$

We have restricted ourselves to a simple toy language because it allows a variety of low-level programs to be written while still having a simple enough semantics which allows proof of the soundness of the transformations (see [Lac03]). Some simple language features could have been added, but this would only make the proofs of soundness more tedious. More complex features, such as pointers and exceptions, are discussed in Section 11, where we present some ideas on how our methodology can be ported to real programming languages.

## 3 Designing a specification language for transformations

### 3.1 General principles

In our quest to develop a language to specify optimisations which could both be proved to be sound as well as be amenable to mechanical application on programs, we were driven by several requirements:

1. it must be expressive enough to specify a large range of common compiler optimisations;
2. it must be simple enough to facilitate formal analysis, and in particular proofs of soundness of the transformations;

3. it must allow transformation specifications to be automatically applied to programs without requiring any low level programming.

The approach we follow to satisfy these requirements is based on rewriting, temporal logic, and model checking. Transformations are expressed in a language that allows their rigorous proof of soundness, supports automatic checking of the applicability of an optimisation to a program, and automates generation of optimised programs.

### 3.2 Conditional rewriting

A rewrite typically consists of a left-hand side pattern that represents several abstract syntax trees that *match* the pattern, and may contain several variables which are given values by a particular match. These are then used to convert the right hand side pattern into a syntax tree. The rewrite is applied by replacing the tree that matches the left hand side with the tree created by the right hand side.

Rewriting is a paradigm that is naturally suitable for formal analysis. Compiler optimisations frequently find common patterns within programs, based on some static analysis or abstract interpretation and replace specific sequences of program instructions by other sequences. However, it is rare that part of a program should be rewritten solely based on a syntactic pattern; some more information may be needed. Often, quite complicated *program analysis* is required to check whether a particular transformation can apply. A rewrite rule can be extended by a *condition* that can be seen as a constraint on the possible matches that are allowed on the left hand side of the rewrite. The conditional rewriting paradigm is consequently appropriate for program transformation. In this case the condition of a conditional rewrite should specify what program analysis is needed to determine whether a transformation applies.

Conditional rewrites can be seen as having a left hand side pattern and a condition, where *both* provide pre-conditions to performing a transformation and can therefore be merged. One can generalise this to a bipartite notion of transformation: an *action* that specifies how to transform a program in terms of some free variables and a *condition* that shows what must hold of these variables for the transformation to apply. The condition specifies the program analysis, and binds the result of this analysis to variables. The rewrite rule then uses this binding to instantiate its replacement pattern. A useful transformation toolkit of the kind described here can be found in the Genesis system [Whi91] where optimising transformations are specified in a specialised language called GOSpeL. In this language one specifies patterns of code that can be optimised and the program analysis required to check that the transformation is correct.

### 3.3 Temporal logic

We make use of temporal logic as a specification language for the side conditions under which a transformation may apply. Temporal logics describe properties of



a system relative to a point in time (or in a particular state of the computation). In our case, the points are nodes (or program points) on the CFGs. These are abstractions of the real state of the program to be run. So a logical judgement is of the form:  $\phi @ n$  which states that the formula  $\phi$  is *satisfied* at node  $n$  of the CFG.

We base the language for expressing conditions on CTL (Computational Tree Logic, [CES96]), which can express many optimisations while still being efficient to model check. LTL is also efficiently checkable, however, specifications of some optimisations, such as branch elimination and several forms of partial redundancy elimination (shown in Section 9), are frequently easier to express with branching quantification which LTL doesn't allow.

We made some modifications to CTL in order to make it easier to express properties of programs, such as the inclusion of past temporal operators ( $\overleftarrow{E}$  and  $\overleftarrow{A}$ ). This allows one to intuitively specify classical compiler analyses: backward analyses uses forward temporal operators, and forward analyses uses backward temporal operators. These extensions for previous state operators have often been included when attempting program analyses [Ste91]. We also extend the next state operators ( $EX$  and  $AX$ ) so that one can specify what kind of edge they operate over. For example, the operators  $EX_{seq}$  and  $AX_{branch}$  stand for “there exists a next state via a *seq* edge” and “for all next states reached via a *branch* edge” respectively.

### 3.4 Model checking

Steffen has previously recognised [Ste91, Ste93a] that traditional dataflow analysis and model checking may be used to perform comparable types of analysis. We explore this analogy by using model checking as the technique for examining applicability of transformations.

In our framework, a transformation consists of two parts: a list of actions that change the program by adding or altering points in the CFG and a side condition which specifies when the actions can be applied, written in a language based on temporal logic. A transformation will be performed in the following way:

1. a model checker is used to find a valuation  $\sigma$  that causes the formula  $\phi$  to be true of the CFG;
2. this valuation is used to perform the changes to the graph specified in the list of actions.

There are four types of action: the *replace* action which replaces a node with another sequence of nodes, the *remove\_edge* and *add\_edge* actions which add and remove edges and the *split\_edge* action which inserts a node between two other nodes joined by an edge.

The side condition language allows specification of global and local conditions, combined with logical and temporal operators. Formulae are built up from basic predicates that describe properties of nodes. First-order CTL is

used to specify properties of nodes and paths in the CFGs. The  $@ n$  notation is used to specify that a CTL formula holds at node  $n$ . Two types of basic predicates are used to obtain information about a node in a CFG:  $node(x) @ n$  holds for a valuation  $\sigma$  if  $\sigma(x) = \sigma(n)$ , and  $stmt(s) @ n$  holds whenever pattern  $s$  matches the statement at node  $n$ . Not every element of a predicate needs to be temporal in nature, some are global predicates that do not refer to any node in particular. For example, the formula  $\phi @ n \wedge conlit(c)$  states that  $\phi$  holds at  $n$  (a local property) and  $c$  is a constant literal (a global property).

## 4 The transformation language: TRANS

We have designed a language for expressing specifications, which we call TRANS, that captures the features described in the previous section. The syntax of TRANS is shown in Figure 4. We overload logical binders and use standard CTL binding rules. The  $@$  operator binds more weakly than operators on node conditions.

The language is simple, yet can express many standard compiler optimisations, particularly with the introduction of *strategies*, which combine transformations to create more complex transformations. As an example of TRANS in use, the constant copy propagation transformation is written as:

$$\begin{array}{l} \text{replace } n \text{ with } x := e[c] \\ \text{if } stmt(x := e[v]) \wedge \overleftarrow{A}(\neg def(v) U stmt(v := c)) @ n \wedge conlit(c) \end{array}$$

In this transformation (described in more detail in Section 8.2), if the content at node  $n$  matches  $stmt(x := e[v])$ , and the only definition of  $v$  that reaches  $n$  is  $v := c$ , then  $v$  can be replaced by  $c$  in the expression  $e$  (where  $e$  can be a structured expression). This specification uses *metavariables*, namely  $n$ ,  $x$ ,  $e$ ,  $c$  and  $v$ , which stand for elements of the program. Within the TRANS language  $e[c]$  denotes an expression containing  $c$  as an operand.

Rewriting is an important tool in this framework. The traditional way to write conditional rewrites (where a node can be replaced by a sequence of nodes) is as follows:

$$literal:pattern \implies pattern_1; pattern_2; \dots; pattern_n$$

This notation is supported in our framework as syntactic sugar and mapped into a *replace* action. For example, the conditional rewrite:

$$\begin{array}{l} n : p \implies q_1; q_2; \dots; q_m, \\ A_1, A_2, \dots, A_k \\ \text{if} \\ \phi \end{array},$$

where  $p$  is the pattern to be matched to the statement at  $n$ , is an alternate

<i>literal</i>	::=	<i>metavar</i>   <i>num</i>   <i>exit</i>   <i>start</i>   <i>seq</i>   <i>branch</i>
<i>expr-pattern</i>	::=	<i>literal</i>   <i>expr-pattern op expr-pattern</i>   <i>expr-pattern</i> [ <i>expr-pattern</i> ]
<i>pattern</i>	::=	<b>if</b> ( <i>expr-pattern</i> )   <b>goto</b> <i>expr-pattern</i>   <i>literal</i> := <i>expr-pattern</i>   <b>skip</b>   <b>ret</b> ( <i>expr-pattern</i> )
<i>node-condition</i>	::=	<i>node-condition</i> $\vee$ <i>node-condition</i>   <i>node-condition</i> $\wedge$ <i>node-condition</i>   $\neg$ <i>node-condition</i>   $\exists$ <i>metavar</i> . <i>node-condition</i>   [ <i>EX</i>   <i>AX</i>   $\overleftarrow{EX}$   $\overleftarrow{AX}$ ] <sub>[<i>literal</i>]</sub> ( <i>node-condition</i> )   [ <i>E</i>   <i>A</i>   $\overleftarrow{E}$   $\overleftarrow{A}$ ] ( <i>node-condition</i> <i>U</i> <i>node-condition</i> )   <i>node</i> ( <i>literal</i> )   <i>stmt</i> ( <i>pattern</i> )
<i>side-condition</i>	::=	<i>side-condition</i> $\vee$ <i>side-condition</i>   <i>side-condition</i> $\wedge$ <i>side-condition</i>   $\neg$ <i>side-condition</i>   $\exists$ <i>metavar</i> . <i>side-condition</i>   <i>node-condition</i> @ <i>literal</i>   <i>pred</i> ( <i>literal</i> <sub>1</sub> , ..., <i>literal</i> <sub><i>n</i></sub> )
<i>action</i>	::=	<i>replace literal</i> with <i>pattern</i> <sub>1</sub> ; <i>pattern</i> <sub>2</sub> ; ... ; <i>pattern</i> <sub><i>n</i></sub>   <i>remove_edge</i> ( <i>literal</i> , <i>literal</i> , <i>literal</i> )   <i>add_edge</i> ( <i>literal</i> , <i>literal</i> , <i>edge-type</i> )   <i>split_edge</i> ( <i>literal</i> , <i>literal</i> , <i>pattern</i> )
<i>transform</i>	::=	<i>action</i> <sub>1</sub> , ..., <i>action</i> <sub><i>n</i></sub> <b>if</b> <i>side-condition</i>   <b>MATCH</b> <i>side-condition</i> <b>IN</b> <i>transform</i>   <b>APPLY_ALL</b> <i>transform</i>   <i>transform</i> $\square$ <i>transform</i>   <i>transform</i> <b>THEN</b> <i>transform</i>

Figure 4: The grammar of TRANS

syntax for the action:

$$\begin{array}{l} \text{replace } n \text{ with } q_1; q_2; \dots; q_m, \\ A_1, A_2, \dots, A_k \\ \text{if} \\ \text{stmt}(p) @ n \wedge \phi \end{array}$$

## 4.1 Macros

A macro definition provides a way to name commonly used formulae. Macros are of the following general form

$$\text{let } p(\vec{x}) \triangleq \phi$$

The expression  $p(\vec{\tau})$  in a formula represents the syntactic substitution  $\phi[\vec{\tau}/\vec{x}]$ , where each variable in  $\vec{x}$  is replaced by the corresponding variable in  $\vec{\tau}$ . This allows one to specify formulae that will be used in several different transformations. Free variables are used in some macros when all the uses of the variables have specific denotations, such as loop head or loop tail.

As examples, two macros which match nodes that are connected and strongly connected, respectively, to  $m$  can be written as: *e.g.*

$$\begin{array}{l} \text{let } \text{connected\_to}(m) \triangleq E(\text{True } U \text{ node}(m)) \\ \text{let } \text{strongly\_connected\_to}(m) \triangleq E(\text{True } U \text{ node}(m)) \wedge \overleftarrow{E}(\text{True } U \text{ node}(m)) \end{array}$$

Macros support the definition of temporal operators *eventually* ( $F$ ) and *forever* ( $G$ ) in terms of *until* operators in the standard way:

$$\begin{array}{l} \text{let } EF(\phi) \triangleq E(\text{true } U \phi) \\ \text{let } AF(\phi) \triangleq A(\text{true } U \phi) \\ \text{let } EG(\phi) \triangleq \neg AF(\neg\phi) \\ \text{let } AG(\phi) \triangleq \neg EF(\neg\phi) \end{array}$$

Before presenting the semantics of this language and further constructs which aid specification of transformations, it may be useful to examine a simple exercise in optimisation, which relies on some well-known optimisations as well as some which are hand-crafted to suit the purpose in hand. This will give a flavour of the system and justify the design of the language.

## 5 An interactive optimisation exercise

We present a worked example where TRANS has been used to interactively optimise a program and illustrate how transformations can be written in TRANS that capture the steps one may wish to apply to optimise a program.

Our starting point is the code from Fig. 2, which has been generated from Pascal source code. We add the syntax  $M[x]$  to  $L_0$  to represent array/memory

0: i := 0	0: i := 0	0: i := 0
1: if (i < 10) goto 12	1: if (i < 10) goto 10	1: h := 0
2: temp2 := i * 3	2: temp2 := i * 3	2: if (i < 10) goto 10
3: temp3 := 1 + temp2	3: temp4 := temp2 + 3	3: temp4 := h + 2
4: temp4 := temp3 + 1	4: M[temp4] := 0	4: M[temp4] := 0
5: M[temp4] := 0	5: temp6 := i * 3	5: temp8 := h + 3
6: temp6 := i * 3	6: temp8 := temp6 + 8	6: M[temp8] := 0
7: temp7 := 1 + temp6	7: M[temp8] := 0	7: i := i + 1
8: temp8 := temp7 + 2	8: i := i + 1	8: h := h + 3
9: M[temp8] := 0	9: goto 1	9: goto 1
10: i := i + 1	10: ret 0	10: ret 0
11: goto 1		
12: ret 0		

(a)

(b)

(c)

0: h := 0	0: h := 2	0: h := 2
1: if (h < 30) goto 8	1: if (h < 32) goto 7	1: if (h < 32) goto 7
2: temp4 := h + 2	2: M[h] := 0	2: M[h] := 0
3: M[temp4] := 0	3: temp8 := h + 1	3: h := h + 1
4: temp8 := h + 3	4: M[temp8] := 0	4: M[h] := 0
5: M[temp8] := 0	5: h := h + 3	5: h := h + 2
6: h := h + 3	6: goto 1	6: goto 1
7: goto 1	7: ret 0	7: ret 0
8: ret 0		

(d)

(e)

(f)

Figure 5: Steps in optimising the example program

$$\begin{array}{l}
n : a := i + c \implies a := j + k \\
\text{if} \\
\overleftarrow{A}(\neg \text{def}(i) \wedge \text{def}(j) \cup \neg \text{node}(n) \wedge \text{stmt}(i := j + d)) @ n \wedge \\
\text{conlit}(c) \wedge \text{conlit}(d) \wedge \text{varlit}(j) \wedge \text{varlit}(i) \wedge k \text{ is } c + d
\end{array}$$

Figure 6: A variant case of constant propagation

access. Some standard, local transformations, such as constant folding and copy propagation, are first applied to the code, as well as dead code elimination. The resulting starting point for further global optimisations is shown in Fig. 5(a).

The computation spread over lines 3 and 4 of Fig. 5(a) can be simplified, as the end result is to assign the value of `temp2 + 2` to `temp4`. This form of algebraic simplification can be generalised to look for an addition between a variable and a constant where the reaching definition of that variable is also an addition between a variable and a constant. Standard libraries of transformations may not capture this special case, but it can be easily written in TRANS, as shown in Fig. 6. The assignment at node  $n$  is rewritten if the right-hand expression is a sum of a variable and a constant and the only definition of that variable is a sum between a constant and a variable. Applying this transformation repeatedly simplifies lines 3 and 8 and allows more dead code elimination, resulting in the code shown in Fig. 5(b).

There are now several transformations that can be applied. In Section 4 we present several applicable standard transformations such as loop strengthening, lazy code motion, lazy strength reduction and common subexpression elimination defined in TRANS. Here, strength reduction replaces the calculations of `i * 3` in lines 2 and 5 with pre-calculated values (stored in a new variable `h`). Further applications of copy propagation, constant folding and dead code elimination results in the code of Fig. 5(c).

At this point, the variable `i` is only used to indicate when to exit the loop. However, this information is also contained in `h`, so the variable `i` could be eliminated. The key to the transformation is identifying two induction variables whose initialisation step have a fixed ratio  $r$ . The transformation shown in Fig. 7 changes the exit condition of the loop accordingly. Note that this specification uses the macros defining loops and induction variables described in Section 7. This transformation, along with more dead code elimination, results in the code shown in Fig. 5(d).

One may observe that all the uses of `h` here are of a simple form *i.e.* in additions to constants. Changing `h` so it always has some constant offset could eliminate one of these additions. As the desired transformation is quite complex, we introduce *strategies*, described formally in Section 6.6, which ease the development of complex transformations. The transformation that implements a general case of replacing one constant by another in these situations is shown in Fig. 8. Applying this transformation (and more dead code elimination) results

$$\begin{array}{l}
b : (v < k_1) \implies w < k_2 \\
\text{if} \\
\text{loop}(p, h, b, t) \wedge \text{basic\_induction\_var}(v, c_1, -) \wedge \text{basic\_induction\_var}(w, c_2, -) \wedge \\
\overline{A}(\neg \text{def}(v) \ U \ \text{stmt}(v := i_1)) \ @ \ h \ \wedge \ \overline{A}(\neg \text{def}(w) \ U \ \text{stmt}(w := i_2)) \ @ \ h \ \wedge \\
A(\neg \text{use}(v) \ \vee \ \text{node}(b) \ U \ \text{def}(v) \ \vee \ \text{exit}) \ @ \ t \ \wedge \ i_2 \ \text{is } r * i_1 \ \wedge \ c_2 \ \text{is } r * c_1 \ \wedge \ k_2 \ \text{is } r * k_1
\end{array}$$

Figure 7: Transformation to apply strength reduction

$$\text{let simple\_use}(v) \triangleq \exists c. \exists x. (\text{stmt}(x := v + c) \wedge \text{conlit}(c))$$

$$\begin{array}{l}
\text{MATCH} \\
\text{loop}(p, h, b, t) \wedge \text{induction\_var}(v, c, u) \wedge \\
\overline{A}(\neg \text{def}(v) \ U \ \text{node}(n) \ \wedge \ \text{stmt}(v := i)) \ @ \ h \ \wedge \\
A(\neg \text{use}(v) \ \vee \ \text{simple\_use}(v) \ U \ \text{out\_loop}) \ @ \ h \ \wedge \\
A(\neg \text{use}(v) \ U \ \text{def}(v) \ \vee \ \text{exit}) \ @ \ t \\
\text{IN} \\
\text{replace } n \ \text{with } v := i + k \ \text{if } \text{true} \\
\text{THEN} \\
\text{APPLY\_ALL} \\
m : (x := v + t_1) \implies x := v + t_2 \\
\text{if} \\
t_2 \ \text{is } t_1 - k \ \wedge \ \neg \text{node}(u) \ @ \ m
\end{array}$$

Figure 8: A transformation to alter an induction variable by a constant

in the code of Fig. 5(e).

A final optimisation would be to eliminate the `temp8` variable and use `h` instead. There are many ways to generalise this step. One simple way is to split it into two transformations. The first replaces the use of `temp8` with `h` and alters `h` directly beforehand and afterwards. This first step can be specified in `TRANS` as shown in Fig. 9. Applying this optimisation followed by algebraic simplification and dead code elimination produces the optimised program shown in Fig. 5(f).

We have demonstrated how `TRANS` can be used to systematically improve a program, with a series of transformations which could have been conceived by a compiler developer to implement particular, subtle optimisations. The fact that these are written in a formal language which supports proof of soundness, however, differentiates this practise from directly implementing ad-hoc optimisations.

We now explain the semantics of `TRANS` and show the specification of a wide range of transformations, including ones developed for loop optimisations.

$$\begin{aligned}
& m : (x := v + c) \Longrightarrow v := v + c, \\
& n : (y := M[x]) \Longrightarrow y := M[v]; v := v - c \\
\text{if} & \\
& \overleftarrow{A}(\neg \text{def}(x) \cup \text{node}(m)) @ m \wedge A(\neg \text{use}(v) \cup \text{node}(n)) @ m \wedge \\
& A(\neg \text{use}(x) \vee \text{node}(n) \cup \text{exit} \vee \text{def}(x)) @ m \wedge \\
& A(\neg \text{use}(v) \cup \exists k. \text{stmt}(v := v + k) \wedge \text{conlit}(k)) @ n
\end{aligned}$$

Figure 9: A transformation to replace an unnecessary induction variable

## 6 Semantics

In this section we describe the semantics of TRANS. First the semantics of the side conditions will be described, then the semantics of the actions and finally the semantics of a complete transformation.

### 6.1 Semantic objects and valuations

Transformations are based on the interpretation of free variables which refer to objects in the program. There are several different sets of objects relating to a program.

**Definition 6.1** *The semantics TRANS refers to the objects which are manipulated in programs in  $L_0$ , the main ones being:*

<i>Instr</i>	<i>The set of possible instructions</i>
<i>Expr</i>	<i>The set of possible expressions</i>
<i>Var</i>	<i>The set of program variables</i>
<i>Num</i>	<i>The set of numbers used in the program</i>
<i>Op</i>	<i>The set of operators on elements of Expr</i>
<i>SynFunc</i>	<i>The set of syntactic functions</i>

Note that  $Var \subseteq Expr$  and  $Num \subseteq Expr$ . We use the symbol  $\oplus$  to denote members of *Op*. Members of *SynFunc* are functions of type  $Expr \rightarrow Expr$  which denote simple syntactic substitution, for example  $\lambda x. x + y$  where  $y$  and  $+$  are elements of  $L_0$ . A restriction that the bound variable only occurs once in the body of the function is made, to ensure each function picks out only one part of a syntax tree.

**Definition 6.2** *The set  $\mathcal{O}$  of objects of the program is defined as*

$$\mathcal{O} = \text{Nodes}(\mathcal{G}) \cup \text{Edges}(\mathcal{G}) \cup \text{Instr} \cup \text{Expr} \cup \text{Op} \cup \text{SynFunc} \quad .$$

Transformations are defined through the use of free variables. We use *MetaVar* as the type of metavariables, and we use  $a, b, \dots$  as metavariables. The type



*MetaVar* can bind to values within the set  $\mathcal{O}$ , defined in 6.2. The type *MetaVar* is specifically used in the translation of side conditions into Binary Decision Diagrams described in Section 10.

The semantics of TRANS is given in terms of a *valuation* function for objects of  $L_0$ .

**Definition 6.3** *A valuation is a mapping from MetaVar to  $\mathcal{O}$ .*

Let *Valuation* be the type of all valuations. A *valuation* can convert a *Pattern* (i.e. the *expr-pattern* non-terminal of TRANS in Fig. 4) into a semantic object. This is, in effect, “substituting” into a pattern containing free variables.

**Definition 6.4** *The partial function  $subst : Valuation \times Pattern \rightarrow \mathcal{O}$  is defined by*

$$\begin{aligned} subst(\sigma, x) &= \sigma(x) && \text{if } \sigma(x) \in Expr \\ subst(\sigma, x \ o \ y) &= subst(\sigma, x) \ \sigma(o) \ subst(\sigma, y) && \text{if } \sigma(o) \in Op \\ subst(\sigma, e[d]) &= \sigma(e)(subst(\sigma, d)) && \text{if } \sigma(e) \in SynFunc \end{aligned}$$

## 6.2 Side conditions

The basis of the side conditions in TRANS are first order CTL formulae. We define the type *NodeCondition* that intuitively corresponds to these connectives, and formally to the language defined by the *node-condition* non-terminal of TRANS. These are connected together using first order logic connectives. The truth of these formulae depend on a *valuation*, a node in the CFG and the CFG itself. Accordingly, we introduce a semantic function  $[\cdot]$  which maps a *NodeCondition* to its meaning:

$$[\cdot] : NodeCondition \rightarrow ((Valuation \times Node \times FlowGraph) \rightarrow Bool)$$

The definition of  $[\cdot]$  follows the semantics of CTL. For convenience we define  $\overleftarrow{\mathcal{G}}$  which is identical to the graph  $\mathcal{G}$  but with direction on every edge inverted.

**Definition 6.5** *The semantic function for node conditions is defined by*

$$\begin{aligned}
\llbracket \phi \vee \psi \rrbracket(\sigma, n, \mathcal{G}) &= \llbracket \phi \rrbracket(\sigma, n, \mathcal{G}) \text{ or } \llbracket \psi \rrbracket(\sigma, n, \mathcal{G}) \\
\llbracket \phi \wedge \psi \rrbracket(\sigma, n, \mathcal{G}) &= \llbracket \phi \rrbracket(\sigma, n, \mathcal{G}) \text{ and } \llbracket \psi \rrbracket(\sigma, n, \mathcal{G}) \\
\llbracket \neg \phi \rrbracket(\sigma, n, \mathcal{G}) &= \text{it is not the case that } \llbracket \phi \rrbracket(\sigma, n, \mathcal{G}) \\
\llbracket \exists x. \phi \rrbracket(\sigma, n, \mathcal{G}) &= \exists v : v \in \mathcal{O} : \llbracket \phi \rrbracket(\sigma[x \mapsto v], n, \mathcal{G}) \\
\llbracket \text{node}(m) \rrbracket(\sigma, n, \mathcal{G}) &= \sigma(m) = n \\
\llbracket \text{stmt}(p) \rrbracket(\sigma, n, \mathcal{G}) &= I(n) \cong_{\sigma} p \\
\llbracket EX_{[l]}(\phi) \rrbracket(\sigma, n, \mathcal{G}) &= \exists m, n : (n, m, l) \in \text{Edges}(\mathcal{G}) : \llbracket \phi \rrbracket(\sigma, m, \mathcal{G}) \\
\llbracket AX_{[l]}(\phi) \rrbracket(\sigma, n, \mathcal{G}) &= \forall m, n : (n, m, l) \in \text{Edges}(\mathcal{G}) : \llbracket \phi \rrbracket(\sigma, m, \mathcal{G}) \\
\llbracket E(\phi U \psi) \rrbracket(\sigma, n, \mathcal{G}) &= \exists p : p \in \text{CPaths}(n, \mathcal{G}) : \text{Until}(p, \phi, \psi) \\
\llbracket A(\phi U \psi) \rrbracket(\sigma, n, \mathcal{G}) &= \forall p : p \in \text{CPaths}(n, \mathcal{G}) : \text{Until}(p, \phi, \psi) \\
\llbracket \overleftarrow{EX}_{[l]}(\phi) \rrbracket(\sigma, n, \mathcal{G}) &= \exists m, n : (m, n, l) \in \text{Edges}(\mathcal{G}) : \llbracket \phi \rrbracket(\sigma, m, \overleftarrow{\mathcal{G}}) \\
\llbracket \overleftarrow{AX}_{[l]}(\phi) \rrbracket(\sigma, n, \mathcal{G}) &= \forall m, n : (m, n, l) \in \text{Edges}(\mathcal{G}) : \llbracket \phi \rrbracket(\sigma, m, \overleftarrow{\mathcal{G}}) \\
\llbracket \overleftarrow{E}(\phi U \psi) \rrbracket(\sigma, n, \mathcal{G}) &= \exists p : p \in \text{CPaths}(n, \overleftarrow{\mathcal{G}}) : \text{Until}(p, \phi, \psi) \\
\llbracket \overleftarrow{A}(\phi U \psi) \rrbracket(\sigma, n, \mathcal{G}) &= \forall p : p \in \text{CPaths}(n, \overleftarrow{\mathcal{G}}) : \text{Until}(p, \phi, \psi)
\end{aligned}$$

The definition of the next operators ( $EX$ ,  $AX$  etc.) includes the optional parameter  $[l]$ , which indicates whether an edge in the graph is a *branch* or *seq* edge. If the statement holds true regardless of which type of branch is used, the parameter may be omitted.

We define *Until* in the following manner.

**Definition 6.6** *Consider a path  $p \in \text{CPaths}(n, \mathcal{G})$ , for some  $n$ , such that  $p = n_0 n_1 \dots n_k$ . The predicate  $\text{Until}(p, \phi, \psi)$  holds if:*

$$\exists j : 0 \leq j \leq k : \llbracket \psi \rrbracket(\sigma, n_j, \mathcal{G}) \wedge \forall 0 \leq i < j. \llbracket \phi \rrbracket(\sigma, n_i, \mathcal{G})$$

In order to capture pattern matching, the specification of the side condition semantics makes use of the relation  $\cong_{\sigma}$  which is a subset of  $\text{Instr} \times \text{Pattern}$  and defined by:

$$\begin{aligned}
I \cong_{\sigma} x := e &= I = \sigma(x) := \text{subst}(\sigma, e) \\
I \cong_{\sigma} \text{if } (e) &= \exists n. I = \text{if } \text{subst}(\sigma, e) \text{ goto } n \\
I \cong_{\sigma} \text{skip} &= I = \text{skip} \text{ or } \exists n. I = \text{goto } n \\
I \cong_{\sigma} \text{ret}(e) &= I = \text{ret}(\text{subst}(\sigma, e))
\end{aligned}$$

The temporal logic formulae can be combined using logical connectives and the  $@$  operator, creating side conditions of the type *Condition* that do not depend on a particular node in the CFG. We define the semantics of these conditions by overloading the semantic function  $\llbracket \cdot \rrbracket$ :

$$\llbracket \cdot \rrbracket : \text{Condition} \rightarrow (\text{Valuation} \times \text{FlowGraph} \rightarrow \text{Bool}) .$$

The definition of this function is straightforward:

**Definition 6.7** *The semantic function for side conditions is defined by*

$$\begin{aligned}
[\phi \vee \psi](\sigma, \mathcal{G}) &= [\phi](\sigma, \mathcal{G}) \text{ or } [\psi](\sigma, \mathcal{G}) \\
[\phi \wedge \psi](\sigma, \mathcal{G}) &= [\phi](\sigma, \mathcal{G}) \text{ and } [\psi](\sigma, \mathcal{G}) \\
[\neg\phi](\sigma, \mathcal{G}) &= \textit{it is not the case that } [\psi](\sigma, \mathcal{G}) \\
[\exists x.\phi](\sigma, \mathcal{G}) &= \exists \tau : \tau \in \mathcal{O} : [\phi](\sigma[x \mapsto \tau], \mathcal{G}) \\
[\phi @ m](\sigma, \mathcal{G}) &= [\phi](\sigma, \sigma(m), \mathcal{G}) \\
[p(\bar{x})](\sigma, \mathcal{G}) &= \widehat{p}(\sigma(\bar{x}), \sigma)
\end{aligned}$$

Here, the logical combination of node conditions is standard. The last clause above refers to global predicates, described next.

### 6.3 Basic Predicates

The TRANS language allows a wide range of *predicates* to be defined, some of which are fundamental predicates, and some of which are simply commonly used macros. We make the distinction between those predicates that are global, and those that are parameterised by node.

#### 6.3.1 Global predicates

Global conditions (such as *conlit*(*c*), which states that *c* is a literal constant) are defined by a family of global predicates (each in a type *GlobalPred<sub>n</sub>* where *n* is the arity of the predicate). The semantics of these expressions varies from predicate to predicate and is stipulated by a family of functions  $\widehat{\cdot}$ , such that for each arity *n* there is a function:

$$\widehat{\cdot} : GlobalPred_n \rightarrow (\mathcal{O}^n \times Valuation) \rightarrow Bool .$$

In the example transformations described in this chapter, the following basic global predicates on *L<sub>0</sub>* are used:

<i>conlit</i> ( <i>x</i> )	<i>x</i> is a constant literal
<i>varlit</i> ( <i>x</i> )	<i>x</i> is a variable literal
<i>freevar</i> ( <i>x</i> , <i>e</i> )	<i>x</i> is a free variable of the expression <i>e</i>
<i>is</i> ( <i>x</i> , <i>e</i> )	the expression <i>e</i> can be statically determined and evaluates to <i>x</i>

Usually, we write “*x* is *e*” instead of *is*(*x*, *e*), in the style of Prolog. The formal definition of the above predicates is as follows

$$\begin{aligned}
\widehat{conlit}(x)\sigma &= \sigma(x) \in Num \\
\widehat{varlit}(x)\sigma &= \sigma(x) \in Var \\
\widehat{freevar}(v, e)\sigma &= \sigma(v) \in FV(subst(\sigma, e)) \\
\widehat{is}(x, e)\sigma &= \sigma(x) = evalC(\sigma, subst(\sigma, e))
\end{aligned}$$

The predicates return false if the function *subst* or *evalC* is undefined when called. The definition of the *is*(*x*, *e*) predicate uses the following auxiliary function:

$$\begin{aligned}
evalC(\sigma, x) &= \sigma(x) && \text{if } \sigma(x) \in Num \\
evalC(\sigma, x \oplus y) &= evalC(\sigma, x) \llbracket \sigma(\oplus) \rrbracket evalC(\sigma, y) && \text{if } \sigma(\oplus) \in Op
\end{aligned}$$

Within this definition  $\llbracket op \rrbracket$  is the application of  $op$  to the surrounding arguments. It is also useful to have one global predicate *fresh*, which succeeds when its argument is bound to the next new variable *i.e.* a variable that has not been mentioned in the program previously.

### 6.3.2 Local predicates

Local predicates describe conditions at particular nodes during execution. The following local predicates are useful for the transformations presented in this paper:

$def(x) @ n$	the statement at node $n$ assigns to variable $x$
$use(x) @ n$	the statement at node $n$ is an assignment, whose expression contains the sub-expression $x$
$trans(e) @ n$	the statement at node $n$ does not assign to any of the free variables in the expression $e$

These predicates are defined in TRANS as macros.

$$\begin{aligned}
let \quad def(x) &\triangleq \exists e. stmt(x := e) \\
let \quad use(x) &\triangleq \exists v, e. stmt(v := e[x]) \vee stmt(\mathbf{if} (e[x])) \vee stmt(\mathbf{ret}(e[x])) \\
let \quad trans(e) &\triangleq \neg \exists v, d. stmt(v := d) \wedge freevar(v, e)
\end{aligned}$$

## 6.4 Actions

Side conditions stipulate which valuations allow the transformation to apply to a program (namely the valuations  $\sigma$  such that  $\llbracket \phi \rrbracket(\sigma, \mathcal{G})$  holds). Given such a valuation, an *action* specifies how to alter the program. An action is defined as a function on flow graphs—a partial function, since it could still fail due to a type mismatch. Accordingly, the semantics of different actions have type:

$$\llbracket \cdot \rrbracket : Action \rightarrow (Valuation \times FlowGraph \rightarrow FlowGraph)$$

There are four types of actions in TRANS; combinations of these actions allow nodes to be added or deleted at any position in the graph.

The *add\_edge* action adds an edge of a particular type between two nodes. If an edge of the correct type already exists between the two nodes then the action has no effect.

**Definition 6.8** *The action  $add\_edge(n, m, e)$  is defined as:*

$$\llbracket add\_edge(n, m, e) \rrbracket(\sigma, \langle N, E, I \rangle) = \langle N, E \cup \{(\sigma(n), \sigma(m), \sigma(e))\}, I \rangle$$

The *remove\_edge* action removes an edge between two nodes. If no such edge exists then the action has no effect.

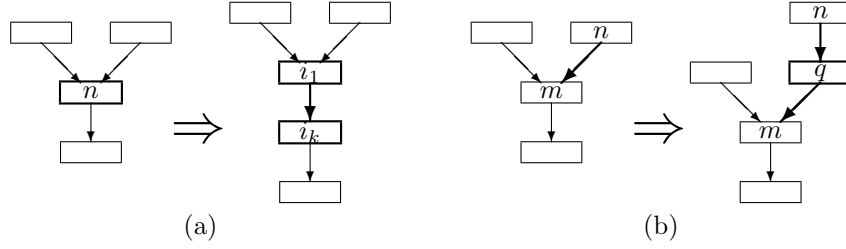

Figure 10: The replace and split\_edge actions

**Definition 6.9** The action  $remove\_edge(n, m, e)$  is defined as:

$$[remove\_edge(n, m, e)](\sigma, \langle N, E, I \rangle) = \langle N, E \setminus \{(\sigma(n), \sigma(m), \sigma(e))\}, I \rangle$$

The *replace* action replaces a node with a sequence of nodes. This is illustrated in Fig. 10(a). The action changes all three components of the graph. It adds the nodes necessary to create the new sequence of instructions, to be connected by a series of *seq* edges. The successor edges of the node being replaced are moved to the end of the block and the labelling function of the graph is altered to map the correct values of the instructions on the nodes in the replacement block.

**Definition 6.10** The action *replace*  $n$  with  $i_1; \dots; i_k$  is defined as:

$$[replace\ n\ with\ i_1; \dots; i_k](\sigma, \langle N, E, I \rangle) = \langle N \cup \{n_2, \dots, n_k\}, E', I \triangleright [n_1 \mapsto subst(\sigma, i_1), \dots, n_k \mapsto subst(\sigma, i_k)] \rangle$$

where  $n_1 = \sigma(n)$  and  $n_2, \dots, n_k$  are nodes not occurring in the original graph and  $\triangleright$  alters the labelling function  $I$  with new bindings. The edge relation  $E'$  is defined as:

$$E' = \{remap\_succ(n_1, n_k, e) \mid e \in E\} \cup \{(\sigma(n_i), \sigma(n_{i+1}), seq) \mid 1 < i < k\}$$

and

$$remap\_succ(x, y, e) = \begin{cases} (m, s, t) & \text{if } x = n, y = m, e = (n, s, t) \\ e & \text{otherwise} \end{cases}$$

The *split\_edge* action alters a graph by inserting a node between two existing nodes joined by a particular edge. This action is useful because it specifies which particular edge is used as placement for a node, in the case where its successor node has several predecessors. This is illustrated in Fig. 10(b), which uses the same labelling function. In this definition  $n$  and  $m$  both represent nodes in the graph, whilst  $e$  is the edge between them that the transformation splits, and  $i$  is the new instruction to be inserted in the split graph.

**Definition 6.11** The action  $split\_edge(n, m, e, i)$  is defined as:

$$\begin{aligned}
& \llbracket \text{split\_edge}(n, m, e, i) \rrbracket(\sigma, \langle N, E, I \rangle) = \\
& \langle N \cup \{q\}, \\
& (E \setminus \{(\sigma(n), \sigma(m), \sigma(e))\}) \cup \{(\sigma(n), q, \sigma(e)), (q, \sigma(m), \sigma(e))\}, \\
& I \triangleright [q \mapsto \text{subst}(\sigma, i)] \rangle
\end{aligned}$$

where  $q$  is a new node not occurring in the original CFG and  $\triangleright$  overwrites a map with a new entry.

It is possible to compose several actions in sequence. For example the action

$$\begin{aligned}
& \text{replace } n \text{ with } x := 4, \\
& \text{split\_edge}(n, m, e, y := x)
\end{aligned}$$

will first perform the node replacement and then perform the edge split. It is straightforward to define how these actions are performed in sequence:

$$\begin{aligned}
\llbracket A_1, A_2, \dots, A_k \rrbracket(\sigma, \mathcal{G}) &= \llbracket A_2, \dots, A_k \rrbracket(\sigma, \llbracket A_1 \rrbracket(\sigma, \mathcal{G})) \\
\llbracket \cdot \rrbracket(\sigma, \mathcal{G}) &= \mathcal{G}
\end{aligned}$$

This completes the definition of the semantics of the action component of transformations. This formalisation, along with the semantics of the side conditions in the previous section, allows one to define the meaning of a complete transformation.

## 6.5 Transformations

This section presents the semantics of a transformation, drawing on the previously defined semantic functions. The overall form of a transformation is:

$$\begin{aligned}
& A_1, A_2, \dots, A_n \\
& \text{if} \\
& \phi
\end{aligned}$$

where each  $A_i$  is some action and  $\phi$  is the side condition. The transformation attempts to compute a valuation  $\sigma$  such that  $\llbracket \phi \rrbracket(\sigma, \mathcal{G})$  is true. It then uses this valuation to perform the actions  $A_1$  to  $A_n$  in left to right order.

Since a side condition can be true under many different valuations, the meaning of a transformation is given by a *set* of functions that transform graphs. The meaning of a transformation depends on a *partial* valuation. A partial valuation is a partial function from metavariables to objects. The semantic function  $\llbracket \cdot \rrbracket$  for transformations will be of type:

$$\begin{aligned}
\llbracket \cdot \rrbracket : & \quad \text{Transformation} \\
& \rightarrow (\text{PartValuation} \times \text{FlowGraph} \rightarrow \mathbb{P}(\text{FlowGraph} \rightarrow \text{FlowGraph}))
\end{aligned}$$

We then define a transformation in TRANS to be the set of transformations we get courtesy of valuations that are compatible with the given partial valuation and make the side condition true.

**Definition 6.12** *The semantic function on transformations is defined as:*

$$\begin{aligned} \llbracket A_1, \dots, A_k \text{ if } \phi \rrbracket(\tau, \mathcal{G}) = \\ \{ \lambda x. \llbracket A_1, \dots, A_k \rrbracket(\sigma, x) \mid \llbracket \phi \rrbracket(\sigma, \mathcal{G}) \text{ holds and } \sigma \upharpoonright \text{dom}(\tau) = \tau \} \end{aligned}$$

where  $f \upharpoonright D$  denotes the function  $f$  restricted to the domain  $D$ .

This definition of the semantics as a set of functions between CFGs makes explicit the non-determinism that stems from the fact that many different substitutions may satisfy the applicability condition of the transformation. This can be seen to correspond to the fact that the transformation may apply to many different parts of the CFG. The intended application for these transformations resolves the non-determinism by choosing one correct valuation, *i.e.* one *local* place to transform.

## 6.6 Strategies

In order to succinctly specify more complex transformations, we introduce *strategies*, which are operators that act upon transformations. In this section we describe four strategies which will be used to define optimisations in Section 9.

### 6.6.1 Matching Free Variables

The MATCH...IN strategy executes a transformation restricted to a valuation that satisfies a particular formula. This strategy is particularly useful in combination with other strategies, as in such cases the desired valuations cannot be simply added to the side condition. For example, the transformation

$$\text{MATCH } stmt(x := e) @ n \text{ IN } T$$

specifies that the transformation  $T$  should be used only when a substitution that makes the formula  $stmt(x := e) @ n$  true is found. Only the variables  $n$ ,  $x$  and  $e$  are restricted; any other free variables in  $T$  are unaffected. Often  $T$  is a complex transformation made of strategies.

The MATCH...IN strategy is defined in terms of the semantic function for transformations.

**Definition 6.13** *The MATCH...IN strategy is defined by the following extension to the semantic function on transformations:*

$$\begin{aligned} \llbracket \text{MATCH } \phi \text{ IN } T \rrbracket(\tau, \mathcal{G}) = \\ \{ f \mid \llbracket \phi \rrbracket(\sigma, \mathcal{G}) \text{ holds, } \sigma \upharpoonright \text{dom}(\tau) = \tau, f \in \llbracket T \rrbracket(\tau \cup (\sigma \upharpoonright FV(\phi)), \mathcal{G}) \} \end{aligned}$$

where  $FV(\phi)$  is the set of free variables occurring in the formula  $\phi$ .

### 6.6.2 Global Transformation

With Definition 6.12 of the semantics of transformations as a set of functions between CFGs, the natural solution is to choose one particular instance to solve the non-determinism. An alternative which is required for some program transformations is a global transformation that applies in every place, *i.e.* for every valuation that satisfies the side condition. This is achieved with the APPLY\_ALL strategy.

**Definition 6.14** *The APPLY\_ALL strategy is defined by:*

$$[\text{APPLY\_ALL}(T)](\tau, \mathcal{G}) = \{f_1 \circ f_2 \circ \dots \circ f_n \mid f_i \in [T](\tau, \mathcal{G}) \setminus \{f_1 \dots f_{i-1}\}\}$$

where  $n$  is the (finite) number of elements of  $[T](\tau, \mathcal{G})$ .

In other words, the APPLY\_ALL strategy applies all of the possible transformations in any order.

### 6.6.3 Nondeterminism

In certain cases it is useful to extend the nondeterminism of transformations when combining them. The operator  $\square$  on transformations corresponds to a nondeterministic choice which is made available for when valuations are matched.

**Definition 6.15** *The  $\square$  operator on transformations is defined by the following extension to the semantic function on transformations:*

$$[T_1 \square T_2](\tau, \mathcal{G}) = [t_1](\tau, \mathcal{G}) \cup [t_2](\tau, \mathcal{G})$$

### 6.6.4 Composition

Sequential composition involves performing one transformation directly after another. The composed transformation will only succeed if both component transformations succeed. Composition is done with the  $T_1$  THEN  $T_2$  strategy.

**Definition 6.16** *The THEN strategy is defined by:*

$$[T_1 \text{ THEN } T_2](\tau, \mathcal{G}) = \{f \circ g \mid f \in [T_1](\tau, \mathcal{G}), g \in [T_2](\tau, \mathcal{G})\}$$

This strategy makes most sense intuitively if both  $T_1$  and  $T_2$  are deterministic *i.e.* both  $[T_1]$  and  $[T_2]$  contain only one element.

Four strategies have now been defined and although they are simple they allow transformations to be combined in a very flexible manner. Section 8 describes simpler transformations, whilst Section 9 presents more sophisticated transformations that include strategies. But before introducing these examples, we examine how loops can be recognised within our methodology.



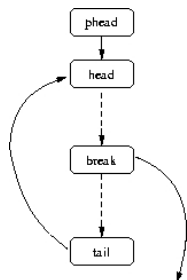

Figure 11: General pattern for a loop

## 7 Identifying loops via dominators

Since our system operates over the control flow graph of the program, it does not naturally have information about the existence and positioning of loop structures. In this section, we show how loops can be recovered from unstructured graphs, and we define the macro *loop* which is used extensively in our specification of loop optimisations in Section 9.

The key concept is that of *dominance*. A node  $n$  is said to dominate a node  $m$  if every path from the start of the program to node  $m$  must pass through node  $n$ . This can be expressed as a temporal logic formula, by stating that at the start node there does not exist a path that satisfies  $\neg node(n)$  until the path reaches  $m$ .

$$let\ dom(n, m) \triangleq \neg E(\neg node(n) U node(m)) @ start$$

Conversely, we can define *post dominance*, when every backward path from the exit node to  $m$  must pass through  $n$ .

$$let\ pdom(n, m) \triangleq \neg \overleftarrow{E}(\neg node(n) U node(m)) @ exit$$

For the purpose of this paper, the general pattern for a reducible loop is depicted in Fig. 11. It is generally the case that optimising compilers do not deal with irreducible loops, and we consequently do not account for this case [Tar73]. Some loops test their condition after their loop bodies, for example do-while loops within the Java programming language, we do not account for this case since it can be easily converted into the form we look for by copying the loop body to a sequence of nodes ahead of the loop header.

Loops are characterised by certain key nodes: the *pre-header* ( $phead$ ), the *head*, the *tail* and the *break* nodes. We specify the order of the key nodes in the loop with dominance relations. The pre-header must dominate the head ( $dom(phead, head)$  must hold) and the break node must post-dominate the tail ( $pdom(break, tail)$  must hold). In addition, the pre-header node must be the immediate predecessor of the head node:

$$AX(node(head)) @ phead$$

A loop is identified by the existence of a *back – edge* between head and tail. The back edge relation can be specified as an edge between two nodes whose source can reach its target in a backwards direction:

$$\text{let } \text{back-edge}(tail, head) \triangleq (EXnode(head)) \wedge (\overleftarrow{EF}node(head)) @ tail$$

It is worth noting that the *back-edge* predicate may hold true at positions other than those within the context of loop analysis (since we allow unrestricted *goto* with  $L_0$ ). This is acceptable for our purposes, since the loop-related transformations refer to the *loop* definition, defined later in this section, which specifically binds the *back-edge* definition to the loop tail and head nodes. We can now define the relation between the four key nodes that define a loop

$$\text{let } \text{loop}(phead, head, break, tail) \triangleq \begin{array}{l} \text{dom}(phead, head) \wedge \text{pdom}(break, tail) \wedge \\ AX(node(head)) @ phead \wedge \\ \text{back-edge}(tail, head) \end{array}$$

Some optimisations such as our version of strength reduction apply only to *well-structured loops*, whose only entry is the head node and only exit is the break node. To identify such loops, nodes inside the loop and outside the loop are distinguished. Execution of nodes inside the loop lead eventually to the break node before either re-entering the loop or exiting the program. So all paths from nodes outside the loop reach either the exit or pre-header without going through the break

$$\text{let } \text{out\_loop} \triangleq A(\neg node(break) U node(phead) \vee exit)$$

An illegal jump out of the loop requires the existence of a node that is not the break node but has a successor outside the loop.

$$\text{let } \text{out\_jump} \triangleq \neg node(break) \wedge EX(out\_loop)$$

An illegal jump into the loop can be defined in a similar manner.

$$\text{let } \text{in\_jump} \triangleq \neg node(head) \wedge \overleftarrow{EX}(out\_loop)$$

These predicates allow us to define well-structured loops:

$$\text{let } \text{wsloop}(phead, head, break, tail) \triangleq \begin{array}{l} \text{loop}(phead, head, break, tail) \wedge \\ A(\neg \text{out\_jump} U \text{out\_loop}) @ head \wedge \\ A(\neg \text{in\_jump} U \text{out\_loop}) @ head \end{array}$$

This definition of loops is used within the strength reduction and loop fusion transformations described in the following two sections. Intuitively, it captures loops that have some block of sequential instructions up to a tail node, from which an edge goes back to the loop header. Somewhere within this loop there is a node that has a branch that allows one to break out of the loop, called the *break* node. A *pre-head* node is also matched, to support the hoisting of instructions to the place immediately preceding the loop.

$$\begin{array}{l}
n : (x := e) \implies \text{skip} \\
\text{if} \\
\neg EX(E(\neg \text{def}(x) \ U \ \text{use}(x) \wedge \neg \text{node}(n))) \ @ \ n
\end{array}$$

Figure 12: Specification of dead code elimination

## 8 Example transformations

This section provides examples of common optimising transformations that can be specified in TRANS, and which are amongst transformations that are found in the optimising phase of many compilers. However, the presentation here may differ from standard presentations in the sense that each transformation may be only a *part* of a more complex optimisation; the improvement in code will occur when it is combined with other transformations, such as dead code elimination. Specifying the transformations in this modular way supports experimenting with application of transformations in different orders to increase efficiency. The TRANS language also makes the transformation more amenable to formal analysis, for example proving that the transformation is semantics preserving.

### 8.1 Dead code elimination

Dead code elimination removes a definition of a variable if it is not used in the future. The rewrite simply removes the definition:

$$n : (x := e) \implies \text{skip}$$

The side condition on this transformation is that all future paths of computation should not use this definition of  $x$  or, more precisely, there does not exist a path with a node that uses  $x$  without a different instruction re-assigning to  $x$  first. This can be specified using the  $E(\dots U \dots)$  construct, noting that  $x$  could be used at node  $n$  itself. So the paths that should be identified are those not using  $x$  until the formula  $\text{use}(x) \wedge \neg \text{node}(n)$  holds. The final specification of dead code elimination is shown in Fig. 12.

### 8.2 Constant propagation

Constant propagation is a transformation where the use of a variable is replaced with the use of a constant known before the program is run (*i.e.* at compile time). The standard method of finding out if the use of a variable is equivalent to the use of a constant is to find all the possible statements where the variable could have been defined, and check that in all of these statements, the variable is assigned the same constant value. The rewrite itself is simple:

$$n : (x := e[v]) \implies x := e[c]$$

$$\begin{array}{l}
n : (x := e[v]) \implies x := e[c] \\
\text{if} \\
\overleftarrow{A}(\neg \text{def}(v) \ U \ \text{stmt}(v := c)) \ @ \ n \ \wedge \ \text{conlit}(c)
\end{array}$$

Figure 13: Specification of constant propagation

This rewrite uses the term  $e[v]$  to find an expression  $e$  with sub-expression  $v$ . Note that, as per Definition 6.1, a variable  $v$  matches against *one* occurrence of the sub-expression in  $e$ . The rewrite then replaces the occurrence that has been matched. So if  $e$  matches the expression  $x + (x - 2)$ , with  $v$  matching the left hand  $x$  and  $c$  matching  $3$ , then the rewrite inserts the expression  $3 + (x - 2)$ .

For the rewrite to be correct,  $v$  and  $c$  must be restricted so that  $v$  necessarily equals  $c$  at the given point. The idea is that if all backward paths from node  $n$  are followed, then the first definition of  $v$  encountered must be of the form  $v := c$ . As all such paths must be checked, the  $\overleftarrow{A}(\dots)$  constructor is appropriate. To fit into the “until” path structure we can observe that requiring the first definition on a path to fulfil a property is equivalent to requiring that the path satisfies non-definition until a point where it is at a definition and the property holds. The full specification of constant propagation is given in Fig. 13.

This transformation is equivalent to standard constant propagation as found in existing compilers. Sometimes it is useful to propagate other entities such as variables; the transformation specifications in these cases are almost identical.

There are several extensions to constant propagation that are quite specialised and require complex algebraic reasoning; a survey of their computational complexity can be found in [MOR01]. Conditional constant propagation is presented in [WZ91]. These extensions expose a current limitation of TRANS: it does not allow recursive pattern matching facilities, therefore expressions of arbitrary complexity cannot be folded. It only takes account of expressions of the form of *constant op constant*. Further extensions to TRANS could be used to capture these special cases.

### 8.3 Strength reduction

Strength reduction is a transformation that replaces multiplications within a loop structure with additions that compute the same value. This is beneficial since the computational cost of multiplication is usually greater than that of addition.

For strength reduction to apply, a basic induction variable and a derived induction variable dependent on it within the loop must be identified. Within a loop, a *basic induction variable* is one that has only one assignment of the form  $v := v + c$ . A *derived induction variable* of the loop is a variable that is linearly dependent on a basic induction variable  $v$ . The optimisation is illustrated in Fig. 14. We use  $n$  to denote the node at which the induction variable increments, and  $m$  to denote the node at which the derived induction variable is assigned

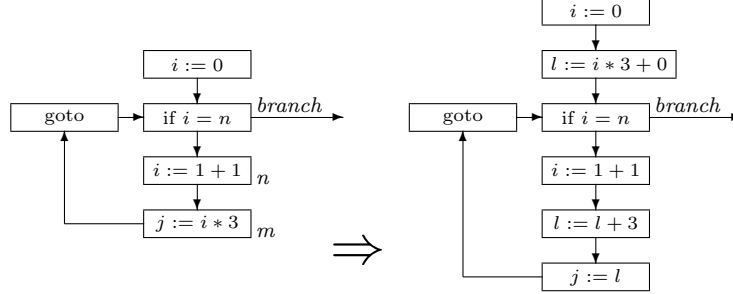

Figure 14: Strength reduction

to within the loop.

The following relation states that  $v$  is an induction variable that is incremented at program point  $m$  with increment  $c$ :

$$\text{let } \text{basic\_induction\_var}(v, c, m) \triangleq \neg \text{out\_loop} \wedge (\text{stmt}(v := v + c) @ m \wedge A(\text{node}(m) \vee \neg \text{def}(v) U \text{out\_loop})) @ \text{head}$$

A linearly derived induction variable is one that has only one assignment in the loop assigning it to a linear function of the variable it depends on. This can be detected using the predicate *dependent\_var*:

$$\text{let } \text{linear\_def}(w, v, k, d) \triangleq (\text{stmt}(w := v * k) \wedge d \text{ is } 0) \vee \text{stmt}(w := v * k + d)$$

$$\text{let } \text{dependent\_var}(w, v, k, d) \triangleq \neg \text{out\_loop} (\wedge \text{linear\_def}(w, v, k, d) @ n \wedge A(\text{node}(n) \vee \neg \text{def}(w) U \text{out\_loop})) @ \text{head}$$

Finally, the dependent variable  $w$  is initialised before the start of the loop in the transformed program. In the first iteration of the loop the value of  $w$  between the head of the loop and its first definition will be different in the transformed program compared to the original program. To ensure the value difference does not matter the following invariant must be preserved:

$$A(\neg \text{use}(w) U \text{def}(w) \vee \text{exit}) @ \text{head}$$

In other words, either the variable  $w$  cannot be used between the head of the loop and its first definition within the loop or control flow leaves the loop if the variable  $w$  is not live.

When these conditions are satisfied, the strength reduction transformation introduces a fresh variable  $w'$  and replaces the assignment  $w := v * k$  with  $w := w'$ . In order to maintain the correct value of  $w'$ , it is necessary to add the assignment  $w := w + \text{step}$ , where  $\text{step}$  is matched to the value of  $c * k$  (using the *is* predicate) after execution of the assignment  $v := v + c$ . In addition  $w$  must be initialised to the correct value just after the pre-header of the loop. The overall transformation is specified as in Fig. 15 .

$$\begin{array}{l}
phead : s \implies s; w' := v * k + d, \\
n : (w := v * k) \implies w := w', \\
m : (v := v + c) \implies v := v + c; w' := w' + step \\
\text{if} \\
loop(phead, head, break, tail) \wedge \\
basic\_induction\_var(v, c, m) \wedge dependent\_var(w, v, k, d) \wedge \\
A(\neg use(w) \vee def(w) \vee exit) @ head \wedge \\
conlit(k) \wedge conlit(c) \wedge step \text{ is } k * c \wedge fresh(w')
\end{array}$$

Figure 15: Specification of strength reduction

### Variations

The above transformation introduces a new variable and on its own only adds new calculations and does not make code any faster. This is a case where cleaning up transformations are needed. In particular, repeatedly applying variable propagation and dead code elimination removes the calculations involving the original dependent variable  $w$ .

Some loop strengthening algorithms (including the one in [ALSU07]) find more types of dependent variables. Specifically, dependent variables may exist that are a linear function of an induction variable but their definition is in terms of other dependent variables. Detecting this kind of dependent variable is appropriate when all loop strengthening is done in one monolithic transformation. In our framework, where small transformations are iterated, the complex approach is not necessary since repeated strengthening along with variable propagation and algebraic simplification will eventually strengthen variables such as  $w$  above.

A more complex version, combining strength reduction with code motion [KRS] needs the addition of TRANS strategies and is described in Section 9.3. There are even more sophisticated induction and dependent variable detection techniques that are beyond the scope of both this paper and the TRANS language. For example see [vE01] where some advanced algebraic reasoning is required.

### 8.4 Branch elimination

A jump statement such as depicted in Fig. 16(a) where two branches of a conditional lead to the same node can be rewritten to a `skip`; the two conditional edges are replaced by a sequential edge. The specification of this transformation is given in Fig. 17(a).

Branch elimination can also disconnect an unused branch of a conditional, as shown in Fig. 16(b). A pattern like this might occur after other transformations. The optimisation is based upon two transformations: one for recognising ‘always true’ conditions and one for recognising ‘always false’ conditions. The ‘always-true’ case is specified in Fig. 17(b).

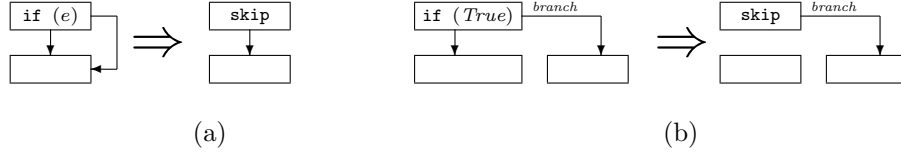

Figure 16: Two cases of branch elimination

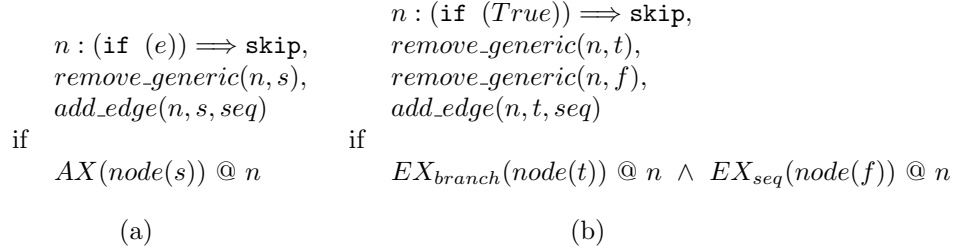

Figure 17: Specification of two variants of branch elimination

## 9 Example transformations using strategies

Strategies provide a way of exploiting the non-determinism of matching within the side conditions of transformations. Here we describe transformations that use strategies to alter the control flow of a program.

### 9.1 Skip elimination

Some transformations, such as dead code elimination, may leave `skip` instructions in the program being optimised. As illustrated in Fig. 18, these are unnecessary and can be removed.

A `skip` statement may have several predecessors but has only one successor. To remove the `skip` statement, it is necessary to remove all edges connected to it and add an edge between each predecessor to the successor. The strategy language is very suitable for such manipulations: a `MATCH` strategy locates a `skip` instruction and its unique successor, and the `APPLY_ALL` strategy performs the edge removal. The resulting specification of skip elimination is

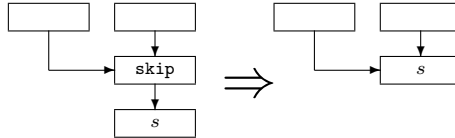

Figure 18: Skip elimination

let  $remove\_generic(n, m) \triangleq remove\_edge(n, m, seq); remove\_edge(n, m, branch)$  .

```

MATCH
  stmt(skip)  $\wedge$  AX(node(s)) @ n
IN
  APPLY_ALL
    remove_edge(p, n, e)
    add_edge(p, s, e)
  if
     $\overleftarrow{EX}_e(node(p))$  @ n
  THEN
    remove_generic(n, s)

```

Figure 19: Specification of skip elimination

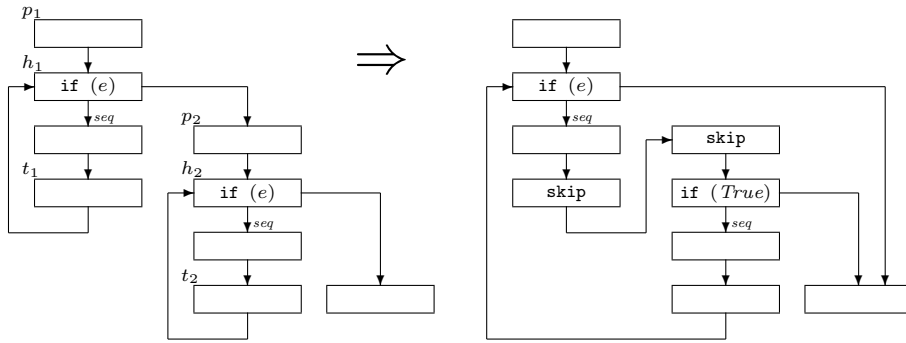

Figure 20: Loop Fusion

shown in Fig. 19. It uses an action  $remove\_generic$  which removes possibly existing edges between two nodes independently of their type (*i.e.* branch, seq). Recall that an `APPLY_ALL` strategy executes the transformation for every matching substitution of free variables (given that  $n$  and  $s$  are bound in the `MATCH` strategy).

## 9.2 Loop fusion

Loop fusion, as illustrated in Fig. 20, is a control flow transformation which fuses two consecutive indexed loops into one. This often makes the code more time-efficient since it reduces the number of increment instructions to  $i$  and allows more opportunity for instruction scheduling<sup>1</sup>.

<sup>1</sup>However, this transformation may not produce faster code, especially as it can introduce worse cache behaviour.



The specification of fusion must identify two loops. To make the transformation simpler, the specification shown here is restricted to loops that follow a `for`-like pattern, *i.e.* where the break node is the same as the header node and whose tail node increments the induction variable of the loop. The macro for identifying loops introduced in Section 8.3 is used twice here to verify that  $loop(p_1, h_1, h_1, t_1)$  and  $loop(p_2, h_2, h_2, t_2)$ . These definitions specify the header and break nodes as the same node (since they are bound to the same meta-variable). Loops can be identified as consecutive by checking that all the second loop's pre-header's immediate predecessors are the break node of the first loop, *i.e.*

$$\overleftarrow{AX}(node(h_1)) @ p_2$$

The node *cont* that follows the break in the second loop (*i.e.* where control leaves the loop) is detected with the following predicate:

$$EX(node(cont) \wedge out\_loop_2) @ h_2$$

The loops must be indexed in the same manner. Firstly, both the pre-header nodes (initialising the induction variable) and the break nodes must have the same instruction:

$$same\_instr(p_1, p_2) \wedge same\_instr(h_1, h_2)$$

where *same\_instr* is defined by:

$$let\ same\_instr(n, m) \triangleq \exists s. stmt(s) @ n \wedge stmt(s) @ m .$$

Furthermore, both loops must have a common induction variable  $x$  (in the following formula  $basic\_induction\_var_i$  is defined as in Section 8.3 for either the first or second loop):

$$basic\_induction\_var_1(x, c, t_1) \wedge basic\_induction\_var_2(x, c, t_2)$$

Since the transformation is being applied to `for`-pattern loops, the specification stipulates that the basic induction variable is incremented at the tails of the loops. Finally, both exit conditions of the loops must leave the loop by a *seq* edge:

$$EX_{seq}(out\_loop_1) @ h_1 \wedge EX_{seq}(out\_loop_2) @ h_2$$

It is also necessary for initialisation, increment and exit values ( $i$ ,  $c$ , and  $k$  respectively) to be unchanged between the two loops. In the transformation presented below they are restricted to be constant literals. For the loops to be successfully fused, we need to ensure that the statements in the second loop do not depend on the first loop. To this end, the predicate *ind\_expr* holds of an expression whose components are not defined within the first loop:

$$let\ ind\_expr(e) \triangleq \neg \overleftarrow{E}(trans(e) \cup \neg trans(e) \wedge \neg out\_loop_1)$$

The predicate *independent* holds for nodes that do not depend on the first loop using the definition  $ind\_expr(e)$ .

$$\begin{aligned}
& h_2 : (\mathbf{if} (x \oplus k)) \implies \mathbf{if} (True), \\
& p_2 : x := i \implies \mathbf{skip}, \\
& t_1 : (x := x + c) \implies \mathbf{skip}, \\
& \mathit{move\_edge}(t_2, h_2, h_1), \\
& \mathit{move\_edge}(h_1, p_2, cont), \\
& \mathit{move\_edge}(t_1, h_1, h_2), \\
\mathbf{if} & \\
& \mathit{loop}(p_1, h_1, h_1, t_1) \wedge \mathit{loop}(p_2, h_2, h_2, t_2) \wedge \\
& \overleftarrow{AX}(\mathit{node}(h_1)) @ p_2 \wedge \\
& EX(\mathit{node}(cont) \wedge \mathit{out\_loop}_2) @ h_2 \wedge \\
& \mathit{same\_instr}(p_1, p_2) \wedge \mathit{same\_instr}(h_1, h_2) \wedge \\
& \mathit{basic\_induction\_var}_1(x, c, t_1) \wedge \mathit{basic\_induction\_var}_2(x, c, t_2) \wedge \\
& EX_{seq}(\mathit{out\_loop}_1) @ h_1 \wedge EX_{seq}(\mathit{out\_loop}_2) @ h_2 \wedge \\
& A(\mathit{independent} \ U \ \mathit{out\_loop}_2) @ h_2 \wedge \\
& \mathit{conlit}(i) \wedge \mathit{conlit}(n) \wedge \mathit{conlit}(c)
\end{aligned}$$

Figure 21: Specification of loop fusion

$$\begin{aligned}
\mathit{let\ independent} & \triangleq \\
& \mathbf{skip} \vee \exists e. \mathit{ind\_expr}(e) \wedge (\mathit{stmt}(\mathbf{if} (e)) \vee \mathit{stmt}(- := e) \vee \mathit{stmt}(\mathbf{ret}(e)))
\end{aligned}$$

This expression can then be used to state that all the statements in the second loop are independent:

$$A(\mathit{independent} \ U \ \mathit{out\_loop}_2) @ h_2$$

If these conditions are satisfied, the transformation will fuse the loops by connecting the tail of the first loop to the head of the second loop, the tail of the second loop to the head of the first loop and the break of the first loop to the *cont* node. The macro *move\_edge* is used to perform these connections as defined by:

$$\mathit{let\ move\_edge}(a, b, c) \triangleq \mathit{remove\_edge}(a, b, seq), \mathit{add\_edge}(a, c, seq)$$

The increment of the induction variable from the first loop and the initialisation and break from the second loop must be removed. However, it is simpler to replace the break in the second loop with the constant condition *if (True)* and let branch elimination remove the edges later.

The complete specification of loop fusion is shown in Fig. 21. Note that this version implements a restricted version of fusion, as the definition of *independent* does not capture all independent uses within the second loop.

### 9.3 Partial redundancy elimination

Partial redundancy elimination transforms cases like the one shown in Fig. 22. The calculation of the expression  $a + b$  at node  $n$  will have already been computed if one path is taken but not if the other path is taken. The transformation

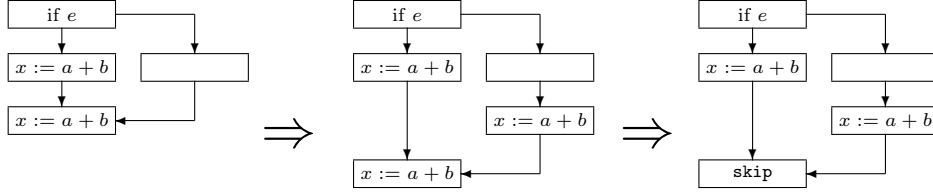

Figure 22: Partial redundancy elimination

adds the calculation of the expression to the other path as well, making the calculation at node  $n$  fully redundant. The idea is that after partial redundancy elimination, common subexpression elimination can remove the calculation at node  $n$  thus improving performance of the left branch of computation.

Expression  $e$  is said to be *available* at point  $p$  if there is some point on every program path to  $p$  where the expression is calculated and if the same expression were evaluated at  $p$  it would result in the same value. This is captured by specifying that for every path backwards from that point  $p$  a calculation of the expression is reached before any of the constituents of that expression is reached. This concept of availability, as well as the notion of an expression being available on *some* path, are captured by the definitions:

$$\text{let } \textit{avail}(e) \triangleq \overleftarrow{A}(\textit{trans}(e) \cup \textit{use}(e))$$

$$\text{let } \textit{avail\_one}(e) \triangleq \overleftarrow{E}(\textit{trans}(e) \cup \textit{use}(e))$$

These two notions can be combined to specify *partial availability*, defined as a point where on some paths the expression is available but not on all paths—the situation to be eliminated:

$$\text{let } \textit{partial\_avail}(e) \triangleq \textit{avail\_one}(e) \wedge \neg \textit{avail}(e)$$

To eliminate the partial redundancy, calculations of an expression are placed at the point where they become unavailable—a point that has predecessors where the expression is available and predecessors where it is unavailable:

$$\overleftarrow{EX}(\textit{avail}(e)) \wedge \overleftarrow{EX}(\neg \textit{avail}(e))$$

However, these calculations should be placed where they will not cause extra calculations on other paths. Fig. 23 illustrates a case where a calculation should not be moved, as there is a chance the result will never be used. A safe place to add a computation of an expression to eliminate a redundancy at node  $n$  can be identified by showing that all paths at that place must lead to node  $n$ , not altering any of the constituents of  $e$  along the way. This extra property finalises

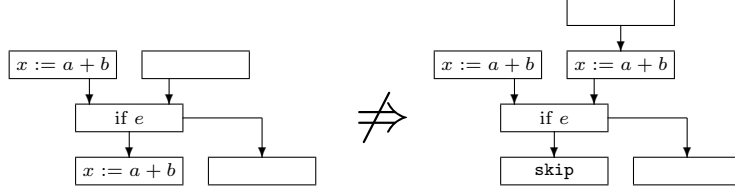

Figure 23: Inappropriate use of partial redundancy elimination

MATCH

$$(use(e) \wedge partial\_avail(e) \wedge \overleftarrow{A}(trans(e) \cup pp(n, e) \vee avail(e))) @ n$$

$$fresh(h)$$

IN

APPLY\_ALL

$$split\_edge(p, m, z, (h := e))$$

if

$$pp(n, e) @ m \wedge \overleftarrow{EX}_z(node(p) \wedge \neg avail(e)) @ m$$

Figure 24: Specification for partial redundancy elimination

the definition of a possible placement ( $pp$ ) of a computation of expression  $e$  to eliminate a partial redundancy at node  $n$ :

$$let\ pp(n, e) \triangleq \neg avail(e) \wedge \overleftarrow{EX}(avail(e)) \wedge A(trans(e) \cup node(n))$$

Partial redundancies are eliminated at points where an expression is calculated, that expression is partially available and every backward path either leads to a point where the expression is available or could be made available with a possible placement:

$$partial\_avail(e) \wedge \overleftarrow{A}(trans(e) \cup pp(n, e) \vee avail(e)) @ n$$

If there is such a node, the transformation shown in Fig. 24 places the computation of  $e$  between each possible placement and each of its predecessors for which  $e$  is not available. This leads to conditions where common sub-expression elimination and dead code elimination are applied to remove the calculation at node  $n$ . Partial redundancy elimination optimisations generally perform what is known as critical edge splitting [KRS92] which increases applicability of an optimisation. We assume edge splitting has been performed before this transformation is applied.

## 9.4 Lazy code motion

Lazy code motion is another form of partial redundancy elimination, with a more global view of moving around the calculation of an expression. Rather than just finding one partial redundancy to eliminate, it finds the “best” places to calculate any expression calculated in the code. The transformation only moves the expression as far away from the original computation as needed to remove redundancies. This reduces any harm to the performance of register allocation on the program. Our formulation of Lazy Code Motion very closely follows that of Steffen and Knoop [KRS92].

The first property of interest to this transformation is *down safety*. A program point is down-safe with respect to an expression  $e$  if all paths from that point reach a calculation of  $e$  without redefining any of the constituents of  $e$ .

$$\text{let } d\_safe(e) \triangleq A(\text{trans}(e) U \text{use}(e))$$

Computations can be placed at down-safe points. The earliest computation point at which  $e$  must be computed is one at which there exists a path backwards that has no down-safe points until it reaches a point where one of the constituents of  $e$  is redefined, if it exists:

$$\text{let } earliest(e) \triangleq \overleftarrow{E}(\neg d\_safe(e) U (\neg \text{trans}(e) \vee \text{start}))$$

The points that are both down-safe and earliest provide sufficient criteria for where to place calculations of  $e$  to eliminate partial redundancy, but ideally the computation should be placed as close before the point of redundancy as possible. We can define places we could safely place a computation of  $e$  after an *earliest* placement. A *later* placement is one that on all backward paths from that point can find a down-safe and earliest place without going through a computation of  $e$  (in which case we have not gone too far).

$$\text{let } later(e) \triangleq \overleftarrow{A}(\neg \text{use}(e) U d\_safe(e) \wedge earliest(e))$$

The latest placement point is now defined as being a *later* placement point that either computes  $e$  or does not have later placement points on all of its successors.

$$\text{let } latest(e) \triangleq later(e) \wedge (\text{use}(e) \vee \neg AX(later(e)))$$

Computations of  $e$  are inserted at points that satisfy this *latest* predicate. These points cover all the computations of  $e$  but are as close to the original computations as possible. The transformation inserts the calculation of  $e$  at this point and store the result in some new variable  $h$ . All the other computations of  $e$  will then just use the result stored in this variable. However, this is not always ideal since a node that satisfies *latest* may calculate the result and put it in  $h$  only to use it straight away and never later on in the program. There is no need to introduce the new calculation when the only place it would be used is the node it was introduced. To avoid this situation, the *isolated* predicate identifies when a node will not pass on the use of a computation of  $e$ :

$$\text{let } isolated(e) \triangleq AX(A(\neg \text{use}(e) U latest(e)))$$

```

MATCH
  partial_avail(e) @ n
  fresh(h)
IN
  APPLY_ALL (insert(h, e) □ remove(h, e))

```

Figure 25: Specification of lazy code motion

The transformation  $insert(h, e)$  inserts a calculation of  $e$  (storing it in variable  $h$ ) after nodes that satisfy  $latest(e)$  but not  $isolated(e)$ :

$$let\ insert(h, e) \triangleq m : s \implies s; h := e \text{ if } (latest(e) \wedge \neg isolated(e)) @ m$$

Calculations of  $e$  can be removed at program points that satisfy  $redundant(e)$ , that is points that are neither  $latest$  or  $isolated$ .

$$let\ redundant(e) \triangleq \neg (latest(e) \vee isolated(e))$$

The removal transformation depends on where the redundant calculation occurs, so it can be written in three variations: one for when the calculation occurs in an assignment, one for when it occurs in a conditional and one for when it occurs in a return statement.

$$\begin{aligned}
let\ rem\_assign(h, e) &\triangleq m : x := c[e] \implies x := c[h] \text{ if } redundant(e) @ m \\
rem\_branch(h, e) &\triangleq m : \mathbf{if} (c[e]) \implies \mathbf{if} (c[h]) \text{ if } redundant(e) @ m \\
rem\_return(h, e) &\triangleq m : \mathbf{ret}(c[e]) \implies \mathbf{ret}(c[h]) \text{ if } redundant(e) @ m
\end{aligned}$$

Then  $remove(h, e)$  is the transformation that removes a redundant use of  $e$  (by using the variable  $h$  instead).

$$let\ remove(h, e) \triangleq rem\_assign(h, e) \square rem\_branch(h, e) \square rem\_return(h, e)$$

The complete transformation, shown in Fig. 25, finds an expression that is partially redundant and then performs all applications of both  $insert$  and  $remove$ .

## 9.5 Lazy strength reduction

Lazy strength reduction is a transformation that combines strength reduction with code motion. Code motion recognises paths where an expression is available; with strength reduction the expression to be reduced is not directly available but can be made available by altering the paths leading up to its calculation.

The goal is to eliminate partially redundant calculations such as of the expression  $v * c$  where  $v$  is a variable literal and  $c$  is a constant literal. Variable  $v$  is said to be *injured* at a node if  $v$  is redefined at this node solely by addition of a constant value. Formally:

$$let\ injured(v) \triangleq \exists d. stmt(v := v + d) \wedge conlit(d)$$

MATCH  
 $partial\_avail_{sr}(v * c) \wedge \overleftarrow{A}(trans_{sr}(e) U pp(n, e) \vee avail(e)) @ m$   
 $fresh(h)$   
 IN  
 APPLY\_ALL ( $insert_{sr}(v, c, h) \square remove_{sr}(v, c, h) \square adjust(v, c)$ )

Figure 26: Specification of lazy strength reduction

The value of the expression  $v * c$  after execution of a node at which  $v$  is injured can be found by adding on the constant  $c * d$ . Using the notion of *injured* nodes the *trans* predicate can be redefined for the expression  $v * c$  to say that either none of the constituents in the expression are redefined or that  $v$  is merely injured.

$$let\ trans_{sr}(v, c) \triangleq \neg def(v) \vee injured(v)$$

This adjusted *trans<sub>sr</sub>* predicate allows the definition of the *d<sub>safe<sub>sr</sub></sub>*, *earliest<sub>sr</sub>*, *later<sub>sr</sub>*, *latest<sub>sr</sub>* and *isolated<sub>sr</sub>* predicates, analogous to the predicates used for specifying lazy code motion:

$$\begin{aligned} let\ d\_safe_{sr}(v, c) &\triangleq A(trans_{sr}(v, c) U use(v * c)) \\ let\ earliest_{sr}(v, c) &\triangleq \overleftarrow{E}(\neg d\_safe_{sr}(v, c) U \neg trans_{sr}(v, c)) \\ let\ later_{sr}(v, c) &\triangleq \overleftarrow{A}(\neg use(v * c) U d\_safe_{sr}(v, c) \wedge earliest_{sr}(v, c)) \\ let\ latest_{sr}(v, c) &\triangleq later_{sr}(v, c) \wedge (use(v * c) \vee \neg AX(later_{sr}(v, c))) \\ let\ isolated_{sr}(v, c) &\triangleq AX(A(\neg use(v * c) U latest_{sr}(v, c))) \end{aligned}$$

Transformations *insert<sub>sr</sub>*( $v, c, h$ ) and *remove<sub>sr</sub>*( $v, c, h$ ) are defined analogously to the transformations used in the specification of lazy code motion. In addition, any node that injures the value  $v * c$  must be altered to update the value  $h$ . The optimiser should do this only on *injured* nodes that have a path to a node that will use  $h$  *i.e.* a node satisfying *redundant*( $v, c$ ). The *adjust* transformation is therefore defined as:

$$\begin{aligned} let\ adjust(v, c) &\triangleq \\ m : v := v + d &\implies v := v + d; h := h + step \\ if\ step\ is\ d * c & \\ &injured(v) @ m \\ &E(\neg latest_{sr}(v, c) \vee isolated_{sr}(v, c) U redundant_{sr}(v, c)) @ m \end{aligned}$$

The specification of lazy strength reduction, shown in Fig. 26, is similar to lazy code motion but uses the new predicates and the additional *adjust* transformation.

This specification illustrates the strength of our approach, in which small transformations are defined independently—and checked for correctness—and then combined using strategies, resulting in the full optimisations. Each individual transformation may not result in improvement of code, but it is the composition, either through specific strategies or indeed an overall loop, which

results in more efficient code. And each transformation can be re-used when devising new optimisations.

Of course, matching these complicated side conditions to programs can be very tedious. If at times the match is not made the code is not improved. Ideally we want to obtain as many matches between side conditions and nodes in CFGs as there are, and for this we apply model checking algorithms, as explained next.

## 10 Applying transformations to programs

The TRANS methodology has been developed to enable transformations to be specified easily and in a format that is suitable for formal analysis, and also to apply the transformations so specified to actual programs. This is why we chose to support coding of the side conditions in a language which supports ease of formal verification and readability, namely CTL. However, to make the system useful in optimisation of actual programs, it needs to allow programs to be optimised in reasonable time and with the minimum of effort on the part of the programming team. For this it is important that transformations on CFGs be performed mechanically and efficiently.

The approach we develop is based on the idea that a set of transformations may be applied many times to programs, and these may be quite large. Thus the main goal is efficient and automatic matching of side conditions to nodes in CFGs, as this is typically the most frequent operation. In this section we present an algorithm that converts TRANS specifications into a variant called TRANS $\mu$ , which is used to semantically model check against the control flow graph.

### 10.1 Modal Mu-calculus

We introduce a language based on TRANS, which we call TRANS $\mu$ , where side conditions are specified using modal mu-calculus [Koz83] rather than CTL. TRANS $\mu$  is obtained by adding to the TRANS grammar following syntax:

$$\begin{aligned} \textit{node-condition} & ::= \mu \textit{ condition-var. node-condition} \\ & \quad | \textit{ condition-var} \end{aligned}$$

In order to tailor the system to our needs without loss of expressiveness compared to CTL, there are some differences between standard modal mu-calculus and the version presented here. The modal mu-calculus is frequently defined to operate over a labelled transition system. Accordingly the  $\diamond$  and  $\square$  operators are frequently parameterised with action names, for example  $\langle a \rangle$  or  $[b]$ . Since CTL formulae do not express formulae in terms of labels, the mu-calculus we use is defined simply in terms of the transition relation between states ( $\rightarrow$ ). This simplification affects neither decidability nor efficiency.

Standard modal mu-calculus with both least and greatest fixed point operators forces the model checking algorithm into exponential complexity. However, translation from CTL to modal mu-calculus and restricting the fragment of



modal mu-calculus needed ensures we can use the fragment which only requires a least fixed point operator, as the *formal monotonicity condition* is satisfied if the number of negations between a fixed point operator and any instance of a bound variable is even. Monotonicity ensures the existence of a least fixed point, and in fact, alternation free modal mu-calculus is checkable within a linear time [CS92]. While this result does not imply that our application process is more or even as efficient as traditional dataflow analysis, it gives some reason to believe that it is possible to develop an optimiser that matches program nodes to side-conditions in a manner efficient enough to support practical use. Our implementation of this approach, while still experimental, reinforces this conclusion that performance can be made acceptable.

## 10.2 Conversion to TRANS $\mu$

In order to translate a CTL formula into a corresponding mu-calculus formula the rewrites for past and future quantifiers below are applied exhaustively:

$$\begin{aligned}
AX(\phi) &= \neg EX(\neg\phi) \\
A(\phi_1 U \phi_2) &= \neg(E(\neg\phi_1 U EX(True)) \vee (\neg\phi_1 \wedge \neg\phi_2)) \\
E(\phi_1 U \phi_2) &= \mu Y. (\phi_2 \wedge FP) \vee (\phi_1 \wedge EX(Y)) \\
\overleftarrow{AX}(\phi) &= \neg\overleftarrow{EX}(\neg\phi) \\
\overleftarrow{A}(\phi_1 U \phi_2) &= \neg(\overleftarrow{E}(\neg\phi_1 U \overleftarrow{EX}(True)) \vee (\neg\phi_1 \wedge \neg\phi_2)) \\
\overleftarrow{E}(\phi_1 U \phi_2) &= \mu Y. (\phi_2 \wedge BP) \vee (\phi_1 \wedge \overleftarrow{EX}(Y)) \\
FP &= \mu Z. \neg EX(True) \vee EX(Z) \\
BP &= \mu Z. \neg\overleftarrow{EX}(True) \vee \overleftarrow{EX}(Z)
\end{aligned}$$

## 10.3 Matching side conditions

The algorithm for applying a transformation specification  $T$  (with side condition  $\phi$ ) to the CFG  $\mathcal{G}$  of the program being optimised is based on finding valuations  $\sigma$  such that  $\llbracket \phi \rrbracket(\sigma, G)$  is true, where  $\llbracket \_ \rrbracket$  is the semantic function for side conditions from Definition 6.5. The *solve* function computes the set of valuations that satisfy  $\phi$  in graph  $\mathcal{G}$ , that is,  $(solve(\phi, G))^* = \{\sigma \mid \llbracket \phi \rrbracket(\sigma, \mathcal{G})\}$ .

### Definition 10.1

$$\begin{aligned}
solve(\phi_1 \vee \phi_2, G) &= solve(\phi_1, G) \cup solve(\phi_2, G) \\
solve(\phi_1 \wedge \phi_2, G) &= solve(\phi_1, G) \cap solve(\phi_2, G) \\
solve(\neg\phi, G) &= solve(\phi, G)^c \\
solve(\exists x.\phi, G) &= \{\sigma \mid \exists \tau \in solve(\phi, G). \forall \nu. \nu \neq x \Rightarrow \sigma(\nu) = \tau(\nu)\} \\
solve(p(\bar{x}), G) &= \{\sigma \mid p(\sigma(\bar{x}))\} \\
solve(\phi @ n, G) &= \cup : m \in Nodes(G) : \{\sigma \mid \sigma(n) = m\} \cap (solve'(\phi, m, G))
\end{aligned}$$

where

$$\begin{aligned}
\text{solve}'(\text{node}(m), n, G) &= \{\sigma \mid \sigma(n) = m\} \\
\text{solve}'(\text{stmt}(s), n, G) &= \text{match}(s, I(n)) \\
\text{solve}'(\phi_1 \vee \phi_2, n, G) &= \text{solve}'(\phi_1, n, G) \cup \text{solve}'(\phi_2, n, G) \\
\text{solve}'(\phi_1 \wedge \phi_2, n, G) &= \text{solve}'(\phi_1, n, G) \cap \text{solve}'(\phi_2, n, G) \\
\text{solve}'(\neg\phi, n, G) &= \text{solve}'(\phi, n, G)^c \\
\text{solve}'(EX(\phi), n, G) &= \cup : (n, n', e) \in \text{Edges}(G) : \text{solve}'(\phi, n', G) \\
\text{solve}'(\overleftarrow{EX}(\phi), n, G) &= \cup : (n', n, e) \in \text{Edges}(G) : \text{solve}'(\phi, n', G) \\
\text{solve}'(X, n, G) &= n(X) \\
\text{solve}'(\mu X.\phi, n, G) &= \text{LFP}(\lambda y. (\text{solve}'(\phi, n \triangleright (X \mapsto y), G) \{\}))
\end{aligned}$$

The predicate *match* above holds true iff the statement *s* is the instruction at node *n* and *n(X)* refers to extracting the valuation bound to *X* at node *n*. In the last rule, LFP is the least fixed point of a function and  $n \triangleright (X \mapsto y)$  refers to binding *X* to the value *y*. The operator  $_c$  represents set complement.

## 10.4 Set Representation

Matching a transformation to a CFG can result in large sets of valuations, and these need to be represented and manipulated efficiently. Binary Decision Diagrams [Ake78] provide a useful way of representing sets through boolean functions that can be used to test for set membership. Reducing ordered BDDs (known as OBDDs) creates canonical forms for each set. Standardised and efficient algorithms for computing conjunction, negation, disjunction and extensional quantification for reduced OBDDs, known as symbolic model checking, are available [McM93, Bry86]. Symbolic model checking has been applied recently to Alias Analysis [WL04, BLQ<sup>+</sup>03].

OBDDs can represent the set of valuations, but only within a known finite domain. This finite restriction could pose a problem if the domain were infinite, and in fact the set of objects  $\mathcal{O}$  from Definition 6.2 is infinite. In manipulating a particular CFG, however, the only elements that can be used in analyses are elements of the flow-graph of the program being analysed, so in practice we are restricted to a finite domain by only transforming one program, and correspondingly one flow-graph, on any given pass.

The one exception to this required finiteness arises with the *is* predicate from Section 6.3, as it ranges over all integers. This problem is resolved in the following way: rather than generalising predicate '*x* is  $e \wedge \phi$ ' to any expression, a set of valuations is found for  $\phi$  using the OBDD based system described above. Once this valuation has been identified the *is* formula can be checked. If the valuation is unbound due to a re-evaluation of  $\phi$  then another binding is found for *x*. In practice most uses of the *is* predicate fall into the aforementioned form, including all of the uses in defining optimisations in Section 8 and Section 9. Thus, the restriction does not limit the expressive power of TRANS in practical terms

## 10.5 Implementation

We have implemented the methodology described above for translating TRANS specifications and matching against a program. We have generated the intermediate code from the LCC compiler [FH91] (rather than writing programs in  $L_0$ ) and matched the side conditions of transformations. Visualisation of the CFGs and the points of match was generated (using the `udraw` package) to allow checking for accuracy of matching.

## 11 Discussion

The transformations from Sections 5, 8, and 9 demonstrate that TRANS is flexible enough to describe a wide range of existing optimising transformations. However, the language is still quite lightweight and it is not surprising that some known transformations from the optimising compiler community cannot be expressed using TRANS. Some transformations cannot be expressed due to the action language not being expressive enough to capture features such as inlining and loop unrolling. These limitations could be resolved by extending the kinds of objects which can be matched in CFGs—for example, by matching against blocks of code. Such extensions would not fundamentally change the nature of TRANS; in particular the side condition language would be the same.

Some transformations, for example conditional constant propagation [WZ91], cannot be expressed due to the limitations of the side condition language. In [LGC02] a method is proposed where analyses of conditional constant propagation can be specified as combinations of other simpler transformations. This approach could possibly be added to TRANS by introducing new combination operators to the language. This is a promising future extension to our work.

In the worst case, the language is extensible in ad-hoc ways *i.e.* with specific predicates that perform certain analyses. For example the predicate *my\_analysis* could be added with the specification:

$$\widehat{my\_analysis}(v, c, n) \equiv$$

$v$  can be replaced by  $c$  at  $n$  due to conditional constant propagation

provided that an algorithm can be written that returns a binary decision diagram representation of this relation. In this case we can specify a transformation by:

$$n : (x := v) \implies x := c \text{ if } my\_analysis(v, c, n)$$

Throughout this paper we have referred to the language  $L_0$ , which lacks many of the features of modern programming languages. We introduce the concept of an *over-approximation* through which the concepts can be carried to a richer language. We say that a CTL formula  $P_2$  is an *over-approximation* of a CTL formula  $P_1$  if for every instance that  $P_1$  holds,  $P_2$  must hold, but not vice-versa. One corollary is that the semantic condition implied by the formula still holds true in different languages: an implementation of transformations over some language  $L$  is correct if the relevant formulae that are over-approximations

in  $L_0$  are also over-approximations in  $L$ . The idea is that the user only has to think about the transformation in terms of a simple language like  $L_0$  and if the transformation is correct in this simple language then it will be correct in a more complicated language that extends  $L_0$ .

One of the most significant differences between  $L_0$  and common languages is aliasing, where variables and memory locations do not necessarily have a bijective relationship. In order to account for the inability to statically compute the exact aliasing relationship under these conditions, many algorithms have been developed that trade off accuracy of computation, with cost of computations [ALSU07]. Therefore when computing alias sets or relations one differentiates between *must* and *may* alias concepts. Variables  $x$  and  $y$  must alias each other if on all paths through the program they refer to the same memory location at some program point. They may alias each other if there exists a path where they refer to the same memory location.

Within a TRANS implementation on a language with aliasing, the *use* and *def* predicates must be redefined to take account of aliasing. Occurrences of  $use(x)@n$  (where  $x$  and  $n$  are metavariables that bind to variables and nodes, respectively) must be refined to  $mayuse(x)@n$  or  $mustuse(x)@n$  depending on the aliasing conditions. This depends upon the polarity of the *use* predicate. If the number of negations preceding the predicate is even the polarity is positive and the occurrence can be replaced by *mustuse*, otherwise it has negative polarity and should be replaced by *mayuse*. This allows an *over-approximation* of the original *use* predicate and is thus sound. The same reasoning applies to the *def* predicate.

The ability to conservatively over-approximate is due to the modular nature of TRANS definitions, and is a comment on the powerful nature of the underlying system. An interesting extension will be to apply transformations in an inter-procedural setting. A partial solution to this is in [Lac03]; however the inter-procedural analysis provided there is not as effective as some inter-procedural dataflow analysis *e.g.* [Kno98]. It may be possible to take some of the ideas from the literature on this subject and provide more powerful inter-procedural analysis for transformations specified in TRANS.

One of the key benefits of describing transformations as rewrite rules with temporal logic side conditions is that it enables the implementation of tools to automatically detect when and where these transformations apply to a particular program. However, for such tools to be truly useful in a real world program development environment detection of applicability must be done very efficiently. The method outlines in Section 10 is being explored further, and we are in the process of checking the efficiency of our implementation on realistic programs. In particular, when applying several transformations in sequence, the efficiency of the transformation engine would be greatly improved with use of an algorithm that incrementally executes the program analysis needed to decide which transformation applies (*i.e.* re-use previous calculations used when deciding that the last transformation applied). This seems viable since the transformations change the program in a highly stylised and local manner. In addition, others have already developed incremental model checking algorithms

that could be adapted [SS94] and an incremental algorithm for calculating regular path queries can be found in [dMDLS03]. Incremental data-flow analysis algorithms can be found in [LR91] and [PS89].

The analysis of transformations could also be further investigated. A method for proving the soundness of transformations has been described [LJWF04]; however, this method becomes quite cumbersome for proving soundness of transformations of real programming languages. Research is needed into how machine assistance could be used to help prove soundness, perhaps using a semi-automated theorem prover. How much user-interaction would be required is unknown; it is as yet unknown whether determining the soundness of transformations specified in TRANS is decidable.

Another kind of formal analysis that can be applied to transformations specified in the manner described in this paper is that of interference analysis, *i.e.* statically determining whether applying one transformation will cause another transformation to either apply when it did not before or not apply when it did before. The general idea is that the logical side conditions and transformations can be combined (either algebraically or via automata) to describe the situation under which interference can happen. This combined description can then be checked for validity *i.e.* whether any program could possibly satisfy it. The free variables in the transformation descriptions mean that this is not a trivial problem. A method is presented in [Lac03] that shows how to determine interference properties for a sub-language of TRANS.

[Lac03] provides a general method for refining and then executing the transformations specified in TRANS over complicated language features. We are currently in the process of implementing such a system with the intention of automating soundness checking for real programs.

## 12 Related work

Several systems have been developed for implementing program transformations from specifications, and each presents a different balance between somewhat conflicting goals: richness of the language to express transformations, support for formal reasoning, and efficiency of application to real-world programs. This section details some of these systems and compares them to the approach taken by us.

### 12.1 DFA&OPT-Metaframe

The Metaframe system [KKKS96] is a toolkit for program analysis and transformation. The complete toolkit is a large-scale project that provides libraries and tools to aid the construction of industrial strength compilers. Part of this system is a transformation tool called the DFA&OPT-Metaframe toolkit. This toolkit in some respects bears the closest relation to the system described here in that it also uses temporal logic as a specification language. Both systems stem from Steffen's work on data-flow analysis as model checking [Ste93b], and

in fact some of the transformations implemented by us have been catalogued by Steffen.

There are, however, differences between the two systems. Metaframe does not use first order temporal logic to specify properties and communicate the results of the analysis to the transformation. The analyses are specified in propositional temporal logic and the resulting program analysis functions are called from a domain specific imperative programming language similar to Pascal. The user writes a temporal logic formula that is automatically converted into a program analyser, which can then be used in the writing of a compiler. During the conversion of a temporal logic formula into an analysis function a formula is partially evaluated to a model checker and optimised to produce an analysis routine similar to that in hand-written compilers (in particular with no loss of speed over the hand-written versions).

The system based on TRANS, as it stands, is not as suitable for compiler construction as the approach above. Due to the high-level and general nature of TRANS, the implementation will not be obviously as fast as equivalent hand-written code or the more specific propositional temporal logic analysis found in Metaframe. Since Metaframe includes a full programming language, it is also more expressive. However, these disadvantages are a consequence of the higher level abstraction chosen by us, and can be remedied with further work. On the other hand, our approach has some advantages. Firstly, it supports simpler specifications than propositional temporal logic, with no need for imperative code. While the combination of  $L_0$  and TRANS is not as expressive as a system that includes a full programming language, it does allow for more concise side conditions. Secondly, having the side conditions and transformations combined in the same simple language with no imperative features allows us to perform formal analysis on the transformations. For example, previous work [LJWF02, LJWF04] shows precisely how optimisation specifications can be proved to be sound, that is, semantics preserving.

Several aspects of the Metaframe system suggest extensions to the work presented here. In particular, the techniques of partial evaluation of model checkers with respect to a particular formula [SCK<sup>+</sup>95] could be adapted to provide a more efficient implementation for TRANS than the prototype implementation which we are currently using, based on our description in Section 10 [Lac03].

## 12.2 Genesis/GOSpeL

The Genesis system implements specifications in the transformation specification language GOSpeL, where optimisations are specified through an ACTION component (with operators for modifying, copying and removing statements of a program similar to TRANS) and a TYPE and PRECOND component which together are equivalent to the condition part of TRANS specifications.

Fig. 27 shows the specification of constant propagation in GOSpeL; we see that this specification can quite easily be converted into TRANS. The ACTION part of the specification states that the statement  $S_j$  is modified by replacing a

---

```

TYPE
  Stmt: Si,Sj,Sl;

PRECOND
  Code_Pattern      /* Find a constant definition */
  any Si: Si.opc == assign AND type(Si.opr_2) == const;

  Depend           /* Use of Si with no other definitions */
  any (Sj,pos):flow_dep(Si,Sj,(=));
  no (Sl,pos):flow_dep(Sl,Sj,(=)) AND (Si != Sl)
  AND operand(Sj,pos) != operand(Sl,pos);

ACTION            /* Change use of Si in Sj to be constant */
  modify(operand(Sj,pos),Si.opr_2);

```

---

Figure 27: Specification of constant propagation in GOSpeL

sub-term with a constant term, in TRANS this is specified as:

$$Sj : (y := e[x]) \Longrightarrow y := e[c]$$

The Code\_Pattern in the specification binds a statement to  $Si$  which assigns a variable to a constant, which is simple to write in TRANS:  $x := c @ Si \wedge conlit(c)$

The DEPEND part of the GOSpeL statement contains two parts, the first indicating that  $Sj$  is flow dependent on  $Si$ , and the second that that  $Sj$  is dependent on no statement other than  $Si$ . Flow dependence indicates whether a variable is used in a statement that has a defining instance at a point it is dependent on. It can be defined in TRANS in the following way:

$$let \ flow\_dep=(x, n, m) \triangleq use(x) @ m \wedge def(x) \wedge E(\neg def(x) U node(m)) @ m$$

The complete direct translation into TRANS of the GOSpeL specification is:

$$\begin{aligned}
& Sj : (y := e[x]) \Longrightarrow y := e[c] \\
\text{if} \\
& x := c \wedge conlit(c) @ Si \\
& flow\_dep=(x, Si, Sj) \\
& \neg \exists Sl. flow\_dep=(x, Sl, Sj) \wedge \neg node(Si) @ Si
\end{aligned}$$

This specification of constant propagation is quite different from the one developed in Section 8.2. The one above is slightly less applicable since all defining instances of the variable we are replacing must be defined at a single point ( $Si$ ).

The GOSpeL system supports matching patterns of code on individual statements and detecting four different types of flow dependencies between nodes, shown in Fig. 28. Each of these dependencies, identified in [PW86], can be expressed in TRANS, however GOSpeL also allows these dependencies to be

Dependency	Description
flow_dep(n,m)	a variable definition at $m$ is used at $n$ .
anti_dep(n,m)	a use of a variable at $n$ is re-defined at $m$ .
out_dep(n,m)	a variable definition at $m$ is output at $n$ .
ctrl_dep(n,m)	$n$ is a conditional statement and $m$ occurs after one of its branches.

Figure 28: Dependencies in GOSpeL

altered with *direction vectors*. For example, the dependency ‘flow\_dep(n,m,<)’ states that an array element definition at  $n$  is indexed at a place before (under the order of some iterative loop) the index of an array element used at point  $m$ . Such predicates cannot be written in TRANS and the language would have to be extended to handle inequality constraints. Another aspect of GOSpeL is that it can match patterns binding variables to whole blocks of code and then move and modify these to enable optimisations such as loop unrolling and inlining. Again, this is not currently possible in TRANS but conservative extensions of block matching operators have been investigated [LdM01]. Some of the transformations described by us (such as partial redundancy elimination) have not been investigated in GoSPeL.

Overall, the philosophy of the TRANS approach is different from GOSpeL in that analyses in TRANS is broken down into smaller components, rather than development of specific (and potentially quite complicated) analyses. This has the advantage of increasing the expressiveness and allowing more uniform formal analysis. Nevertheless, some analysis has been done on transformations in GOSpeL, in particular an approach to prove (by pen-and-paper) that disabling interference does not occur between two transformations is provided in [WS97].

### 12.3 Optimix

Optimix is a graph rewriting system developed by Assmann [Ass96, Ass99]. It can be used for many purposes including specifying some of the transformations described in this paper. It bears a similarity to TRANS since it is based on modifying the control flow graph of a program. Optimix analyses a program by repeatedly applying small rewrites to its graph. Each rewrite extends the graph with nodes that do not represent part of the program but capture information about the program. By using repeated application, each individual rewrite can be quite simple and succinctly specified but combined rewrites propagate quite complex information around the graph. This information, represented as extra nodes or edges can then be used to mark where a program is to be transformed.

The use of a general method makes Optimix very expressive and useful for a variety of transformation and analysis problems. It differs from the TRANS system in that it uses the graph to store intermediate analysis information required for the transformations. The process of matching a temporal logic formula, on the other hand, provides all this information in one step and abstracts away the



detail of each step, from the point of view of the person guiding the optimisation.

## 12.4 Rewriting

There are numerous rewriting-based transformation systems for functional languages, as typically there is no need for complex side conditions. An early implementation of an automatic transformation system can be found in the TAMPR system, which has been under development since the early '70s [Boy70, Boy89]. TAMPR starts with a specification that is translated to pure lambda calculus, and rewriting is performed on pure lambda expressions. OPTRAN is also based on rewriting, but it offers far more sophisticated pattern matching facilities [LMW88]. TrafoLa is another system able to specify sophisticated syntactic program patterns [Hec88]. The Glasgow Haskell compiler allows the programmer to add pragmas to code which allow extra rewrites to be performed on the program during the compilation process [JTH01]. The system MAG [dMS01] provides similar functionality but with more advanced mechanisms for resolving side conditions that are functional equalities. TRANS differs from these systems in having side conditions. These allow a more global view of the program, and are of use when optimising imperative programs.

## 12.5 TTL

Kanade's Temporal Transformation Logic (TTL) [KSK06, KSK07] is a system similar to TRANS, that uses a CTL based proof technique. Kanade's focus is automatic verification of the soundness of the transformations themselves. Accordingly, instead of using the generic rewriting technique that TRANS uses, TTL has a set of transformational primitives. Each primitive represents a common element used within compiler optimisations, for example replacing an expression with a variable. Each of the transformational primitives has an associated soundness condition that, if satisfied, implies the soundness of the transformation. The soundness of transformations within TTL can be proved using the PVS system, which also supports validation of a trace from an instrumented compiler.

The primary difference between TTL and TRANS is that transformation primitives in TTL are less general. Whilst Kanade is able to show that TTL allows automated soundness proofs of some sophisticated optimisations, such as optimal code placement, other common optimisations, for example constant propagation, have not yet been specified, due to the data structures used to implement TTL. The use of specific transformational primitives also raises questions about how general his system is, most notably over the need to introduce further primitives in future. TTL is also seen as a specification language, for other compiler implementations, whilst TRANS can be refined and executed as the optimisation stage of a compiler.

## 12.6 Cobalt and Rhodium

Lerner [LMC03] describes the Cobalt system, which supports automated provability and executable specifications. Rewrite rules are given with temporal conditions expressed in a more restrictive form compared to CTL, which allows the proof, once and for all, of the basic inductive form of the proof technique which holds given sufficient optimisation specific conditions are met. The optimisation specific proof obligations can be discharged automatically using a theorem prover, since they require no inductive heuristics.

The specific nature of Cobalt’s temporal conditions, though common to the dataflow analysis approach, is limited when compared to the generic model checking that TRANS performs with its CTL side conditions. This is one of the main motivations given for developing Rhodium [LMRC05], which is another domain specific language for developing compiler optimisations. Rhodium consists of local rules that manipulate dataflow facts. This is a significant departure in approach from TRANS, since it uses more traditional, data flow analysis based specifications rather than temporal side conditions.

## 12.7 Other program transformation systems

The APTS system of Paige [Pai94] describes program transformations as rewrite rules, with side conditions expressed as boolean functions on the abstract syntax tree, and data obtained by program analyses. These analyses also have to be coded by hand. Other transformation systems that suffer the same drawback include Khepera [FNP97] and Txl [CCH95]. Datalog-like systems express program analyses as logic programs [DRW96]. A more modern system is Stratego [VBT98], which has sophisticated mechanisms for building transformers from a set of labelled, unconditional rewrite rules. The CTADEL system [vE98] is a program transformation system that has been used, amongst other things, to transform code used in the mathematical modelling of meteorological phenomena. The Vista system [ZCW<sup>+</sup>02] is a system of interactive program transformation aimed at the optimisation of programs for embedded systems. It has a fixed selection of hard coded optimisations but has a very advanced user interface for iteratively transforming, viewing and testing code. The SHARLIT system [TH92] provides a toolkit for writing dataflow analyses that generate C++ code. SHARLIT splits the specification of dataflow analyses into flow functions, action routines and simplifier rules, and is intended to provide a particularly good toolkit for global, inter-procedural analysis. The specification language closely resembles custom dataflow analysis, rather than being based on temporal logic. It is evaluated with respect to paths on the CFG, but the system enables sophisticated simplification rules that allow one to specify a wide variety of analyses. This also allows it match information at every basic block and still provide an efficient solution to its data-flow equations. The solutions themselves are computed by an iterative algorithm. Whilst SHARLIT aims to provide an efficient system within which to develop dataflow analyses it does not offer a system within which to verify the soundness of the optimisations.

## 13 Conclusion

This paper presents a language and framework for specifying and executing optimising transformations. A specification language for transformations (TRANS) is introduced that combines elements of rewriting and temporal logic, and this is paired with a model-checking approach which facilitates the application of optimisations to code reminiscent of compiled programs. Many example transformations, some of which are quite sophisticated, were presented to show the flexibility of the language in specifying many useful compiler optimisations. The main thesis of this paper is that it is possible to use a formally defined language which supports rigorous analysis to specify and implement a wide range of realistic optimisations.

We believe that the transformations, as they are written, are quite readable and capture the level of detail found in informal descriptions. The variety of optimisations described in this paper illustrates the flexibility of the TRANS language for specifying realistic optimisations. The underlying CTL-based foundation implies that formal analysis of the transformations is also possible, and we have started to embed the language in the Isabelle theorem prover [NPW02].

We have based this work on a simple imperative language, but we are in the process of porting the methodology into a more realistic setting and show that the transformations are effective. We are exploring the use of the Soot framework for Java [VRCG<sup>+</sup>99] which allows extraction of intermediate code (in Jimple representation) and re-injection of optimised code: this will allow us to compare the results from our tool with code generated in the standard way, and therefore illustrate how it can support the generation of a usable optimising phase from specifications.

## 14 Acknowledgements

David Lacey acknowledges the support and guidance from the Oxford University Programming Tools Group. Richard Warburton is funded by the EPSRC under grant EP/DO32466/1 “Verification of the optimising phase of a compiler”.

## References

- [Ake78] Sheldon B. Akers. Binary decision diagrams. *IEEE Transactions on Computers*, 27(6):509–516, June 1978.
- [ALSU07] Alfred V. Aho, Monica S. Lam, Ravi Sethi, and Jeffrey D. Ullman. *Compilers: Principles, Techniques, and Tools*. Pearson Education, 2nd edition edition, 2007.
- [App98] A. W. Appel. *Modern Compiler Implementation in ML*. Cambridge University Press, 1998.

- [Ass96] U. Assmann. How to uniformly specify program analysis and transformation with graph rewrite systems. In P. Fritzson, editor, *Compiler Construction 1996*, volume 1060 of *Lecture Notes in Computer Science*. Springer, 1996.
- [Ass99] Uwe Assmann. OPTIMIX, A Tool for Rewriting and Optimizing Programs. In *Graph Grammar Handbook, Vol. II*. Chapman-Hall, 1999.
- [BLQ<sup>+</sup>03] Marc Berndt, Ondrej Lhoták, Feng Qian, Laurie Hendren, and Navindra Umanee. Points-to analysis using bdds. In *PLDI '03: Proceedings of the ACM SIGPLAN 2003 conference on Programming language design and implementation*, pages 103–114, New York, NY, USA, 2003. ACM.
- [Boy70] J. M. Boyle. A transformational component for programming languages grammar. Technical Report ANL-7690, Argonne National Laboratory, IL, 1970.
- [Boy89] J. M. Boyle. Abstract programming and program transformation. In *Software Reusability Volume 1*, pages 361–413. Addison-Wesley, 1989.
- [Bry86] R. E. Bryant. Graph-based algorithms for boolean function manipulation. *IEE Transactions on Computers C-35*, 12:1035–1044, December 1986.
- [CCH95] J. R. Cordy, I. H. Carmichael, and R. Halliday. The TXL programming language, version 8. Legasys Corporation, April 1995.
- [CES96] E. M. Clarke, E. A. Emerson, and A. P. Sistla. Automatic verification of finite-state concurrent systems using temporal logic specifications. *ACM Transactions on Programming Languages and Systems*, 8:244–263, 1996.
- [CS92] R. Cleaveland and B. Steffen. A linear-time model-checking algorithm for the alternation-free modal mu-calculus. In Kim G. Larsen and Arne Skou, editors, *Proceedings of Computer Aided Verification (CAV '91)*, volume 575, pages 48–58, Berlin, Germany, 1992. Springer.
- [dMDLS03] Oege de Moor, Stephen Drape, David Lacey, and Ganesh Sittampalam. Incremental program analysis via language factors. Program Tools Group, Oxford., 2003.
- [dMS01] Oege de Moor and Ganesh Sittampalam. Higher-order matching for program transformation. *Theoretical Computer Science*, 269(1-2):135–162, October 2001.

- [DRW96] Steven Dawson, C. R. Ramakrishnan, and David S. Warren. Practical program analysis using general purpose logic programming systems — A case study. *ACM SIGPLAN Notices*, 31(5):117–126, May 1996.
- [FH91] C. W. Fraser and D. R. Hanson. A retargetable compiler for ANSI C. Technical Report CS-TR-303-91, Princeton, N.J., 1991.
- [FNP97] R. E. Faith, L. S. Nyland, and J. F. Prins. KHEPERA: A system for rapid implementation of domain-specific languages. In *Proceedings USENIX Conference on Domain-Specific Languages*, pages 243–255, 1997.
- [Hec88] R. Heckmann. A functional language for the specification of complex tree transformations. In *ESOP '88*, Lecture Notes in Computer Science, pages 175–190. Springer-Verlag, 1988.
- [JTH01] Simon Peyton Jones, Andrew Tolmach, and Tony Hoare. Playing by the rules: Rewriting as a practical optimisation technique in ghc. In *Proceedings of the 2001 Haskell Workshop*, pages 203–233, September 2001.
- [KKKS96] M. Klein, D. Knoop, D. Koschutski, and B. Steffen. DFA & OPT-METAFrame: A toolkit for program analysis and optimization. In *Procs. of the 2nd International Workshop on Tools and Algorithms for the Construction and Analysis of Systems (TACAS '96)*, volume 1055 of *Lecture Notes in Computer Science*, pages 422–426. Springer, 1996.
- [Kno98] Jens Knoop. *Optimal interprocedural program optimization: A new framework and its application*. Number 1428 in LNCS Tutorial. Springer-Verlag, 1998.
- [Koz83] Dexter Kozen. Results on the proposition mu-calculus. *Theoretical Computer Science*, 27, 1983.
- [KRS] J. Knoop, O. Ruthing, and B. Steffen. Lazy strength reduction.
- [KRS92] J. Knoop, O. Ruething, and B. Steffen. Lazy code motion. In *Proceedings of the ACM SIGPLAN '92 Conference on Programming Language Design and Implementation*, volume 27, pages 224–234, San Francisco, CA, June 1992.
- [KSK06] Aditya Kanade, Amitabha Sanyal, and Uday Khedker. A PVS based framework for validating compiler optimizations. In *SEFM '06: Proceedings of the Fourth IEEE International Conference on Software Engineering and Formal Methods*, pages 108–117, Washington, DC, USA, 2006. IEEE Computer Society.

- [KSK07] Aditya Kanade, Amitabha Sanyal, and Uday Khedker. Structuring optimizing transformations and proving them sound. *ENTCS*, 176(3), 2007. Proceedings of the 5th International Workshop on Compiler Optimization meets Compiler Verification (COCV'06).
- [Lac03] David Lacey. *Program Transformation using Temporal Logic Specifications*. PhD thesis, Oxford University Computing Laboratory, 2003.
- [LdM01] D Lacey and O de Moor. Imperative program transformation by rewriting. In R Wilhelm, editor, *Compiler Construction*, volume 2027 of *Lecture Notes in Computer Science*, pages 52–68. Springer Verlag, 2001.
- [LGC02] Sorin Lerner, David Grove, and Craig Chambers. Combining dataflow analyses and transformations. In *Conference Record of the 29th ACM SIGPLAN-SIGACT Symposium on Principles of Programming Languages (POPL 2002)*, 2002.
- [LJWF02] David Lacey, Neil Jones, Eric Van Wyk, and Carl Christian Fredrikson. Proving the correctness of classical compiler optimisation by temporal logic. In *Principles of Programming Languages*, 2002.
- [LJWF04] David Lacey, Neil Jones, Eric Van Wyk, and Carl Christian Fredrikson. Proving correctness of compiler optimizations by temporal logic. *Higher-Order and Symbolic Computation*, 17(2), 2004.
- [LMC03] S. Lerner, T. Millstein, and C. Chambers. Automatically proving the correctness of compiler optimizations, 2003.
- [LMRC05] Sorin Lerner, Todd Millstein, Erika Rice, and Craig Chambers. Automated soundness proofs for dataflow analyses and transformations via local rules. In *POPL '05: Proceedings of the 32nd ACM SIGPLAN-SIGACT symposium on Principles of programming languages*, pages 364–377, New York, NY, USA, 2005. ACM Press.
- [LMW88] P. Lipps, U. Mönke, and R. Wilhelm. OPTRAN – a language/system for the specification of program transformations: system overview and experiences. In *Proceedings 2nd Workshop on Compiler Compilers and High Speed Compilation*, volume 371 of *Lecture Notes in Computer Science*, pages 52–65, 1988.
- [LR91] W. Landi and B. Ryder. Pointer induced aliasing: A problem classification. In *ACM Symposium on Principles of Programming Languages*, pages 93–103, 1991.
- [McM93] K. L. McMillan. *Symbolic Model Checking*. Kluwer Academic Publishers, 1993.

- [MOR01] Markus Müller-Olm and Oliver Rüthing. On the complexity of constant propagation. In D. Sands, editor, *ESOP*, volume 2028 of *LNCS*. Springer-Verlag, 2001.
- [Muc97] S. Muchnick. *Advanced Compiler Design and Implementation*. Morgan Kaufmann, 1997.
- [NPW02] Tobias Nipkow, Lawrence C. Paulson, and Marcus Wenzel. *Isabelle/HOL: A Proof Assistant for Higher-order Logic*, volume 2283 of *LNCS*. Springer-Verlag, 2002.
- [Pai94] R. Paige. Viewing a program transformation system at work. In *Proceedings Programming Language Implementation and Logic Programming (PLILP), and Algebraic and Logic Programming (ALP)*, volume 844 of *Lecture Notes in Computer Science*, pages 5–24. Springer, 1994.
- [PS89] Lori L. Pollock and Mary-Lou Soffa. An incremental version of iterative data flow analysis. *IEEE Transactions on Software Engineering*, 15(12):1537–1549, December 1989.
- [PW86] David A. Padua and Michael J. Wolfe. Advanced compiler optimizations for supercomputers. *Communications of the ACM*, 29(12):1184–1201, 1986.
- [SCK<sup>+</sup>95] B. Steffen, A. Classen, M. Klein, J. Knoop, and T. Margaria. The fixpoint-analysis machine. In *Concurrency Theory, 6th International Conference (CONCUR '95)*, volume 962. LNCS, Springer-Verlag, 1995.
- [SS94] Oleg Sokolsky and Scott Smolka. Incremental model checking in the modal  $\mu$ -calculus. In David Dill, editor, *Computer Aided Verification*, volume 818 of *LNCS*, pages 351–363. Springer-Verlag, 1994.
- [Ste91] B. Steffen. Data flow analysis as model checking. In *Proceedings of Theoretical Aspects of Computer Science*, pages 346–364, 1991.
- [Ste93a] B. Steffen. Generating data flow analysis algorithms from modal specifications. *Science of Computer Programming*, 21:115–139, 1993.
- [Ste93b] B. Steffen. Generating data flow analysis algorithms from modal specifications. *Science of Computer Programming*, 21:115–139, 1993.
- [Tar73] Robert Tarjan. Testing flow graph reducibility. In *STOC '73: Proceedings of the fifth annual ACM symposium on Theory of computing*, pages 96–107, New York, NY, USA, 1973. ACM.

- [TH92] Steven W. K. Tjiang and John L. Hennessy. Sharlit: a tool for building optimizers. *SIGPLAN Not.*, 27(7):82–93, 1992.
- [VBT98] E. Visser, Z. Benaissa, and A. Tolmach. Building program optimizers with rewriting strategies. In *International Conference on Functional Programming '98*, ACM SigPlan, pages 13–26. ACM Press, 1998.
- [vE98] Robert van Engelen. *Ctadel: A Generator of Efficient Codes*. PhD thesis, Leiden University, 1998.
- [vE01] Robert A. van Engelen. Efficient symbolic analysis for optimizing compilers. In R Wilhelm, editor, *Compiler Construction*, volume 2027 of *Lecture Notes in Computer Science*. Springer Verlag, 2001.
- [VRCG<sup>+</sup>99] Raja Vallée-Rai, Phong Co, Etienne Gagnon, Laurie Hendren, Patrick Lam, and Vijay Sundaresan. Soot - a java bytecode optimization framework. In *CASCON '99: Proceedings of the 1999 conference of the Centre for Advanced Studies on Collaborative research*, page 13. IBM Press, 1999.
- [Whi91] Deborah Whitfield. *A Unifying Framework for Optimising Transformations*. PhD thesis, University of Pittsburgh, 1991.
- [WL04] John Whaley and Monica S. Lam. Cloning-based context-sensitive pointer alias analysis using binary decision diagrams. *SIGPLAN Not.*, 39(6):131–144, 2004.
- [WS97] D. L. Whitfield and M. L. Soffa. An approach for exploring code improving transformations. *ACM Transactions on Programming Languages and Systems*, 19(6):1053–1084, 1997.
- [WZ91] Mark N. Wegman and F. Kenneth Zadeck. Constant propagation with conditional branches. *ACM Transactions on Programming Languages and Systems (TOPLAS)*, 13(2):181–210, April 1991.
- [ZCW<sup>+</sup>02] Wankang Zhao, Baoshen Cai, David Whalley, Mark W. Bailey, Robert Van Engelen, Xin Yuan, Jason D. Hiser, Jack W. Davidson, Kyle Gallivan, and Douglas L. Jones. Vista: A system for interactive code improvement. In *LCTES'02-SCOPES'02*. ACM, June 2002.